

2021
STN-1021

CATALOGUE

TOPTUL®

THE MARK OF PROFESSIONAL TOOLS



TOPTUL TAIWAN

No.189, Gongye Rd., Taiping Dist., Taichung City 411

(Ta Li Ind. Park), Taiwan

Tel: +886-4-22715989 (Rep)

Fax: +886-4-22716979

E-mail: service@toptul.com

Website: www.toptul.com



ROTAR GROUP www.toptul.com

STN-1021 Copyright © 2021 TOPTUL All Rights Reserved



TOPTUL®

THE MARK OF PROFESSIONAL TOOLS

NEW PRODUCTS

Find a comprehensive range of quality tools and tool storage in 2021 TOPTUL General Product Catalogue!

- Advanced Design
- Built for Professionals
- Industrial Quality Assurance



Member of SN Registrars (Holdings) Ltd



8327



ROTAR GROUP Since 1981

PROFESSIONAL
MECHANICAL
TOOL SETS



GENERAL WORKSHOP
EQUIPMENT



EPE Foam Modular
Insert Tray System



EPE Foam Modular Tool
Control System

Spanner & Socket sets and tool kits now feature new EPE form insert trays to reduce wear on tools and keep them well-organized. Ideal for tool cabinet arrangements or tool box storage.

New Innovated EPE Foam

High identification, oil resistance and practicality are the notable features of this new innovated EPE Foam. The special, new developed material on top carbon fibre type covered EPE foam is one-piece formed. The top grade cover can resist liquids and it can be easily cleaned with a washer. These new EPE form trays are precisely made and cut by CNC machinery, each cavity is purposely designed for each tool to ensure a perfect fit. The top carbon fibre type covered with high visible printing design and green base, will assist user to instantly recognize if all tools have been returned after use.

New Modular Insert Tray System

NEW MECHANICS TOOL SETS IN EPE FOAM INSERT TRAY

B



W288 x D375 x H30.5 (mm)

▶ 7PCS Windscreen Removal Tool Set

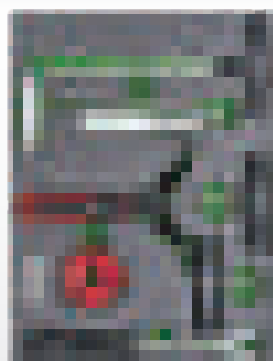

ITEM NO.	DESCRIPTION	QUANTITY
CONTENTS		
1	JJAE1613 Door Upholstery Remover	5 (SET)
1	JLBH0125 Wire Feeder Tool	
2	JLBH0208 Wire Gripping Handle	
1	JLBH0307 72 Feet Triangle Stainless Cutting Wire	
1	JJCD0101 Windshield Removal Tool	
1	JJED0119 Windshield Moulding Release Tool	

Master Tool Set Series

W/7 DRAWER TOOL TROLLEY

213PCS



ITEM NO.
GE-21322

NEW



ITEM NO.
GE-21351

4 DRAWER TOOLS



1ST DRAWER

GEDD348



2ND DRAWER

GED3649

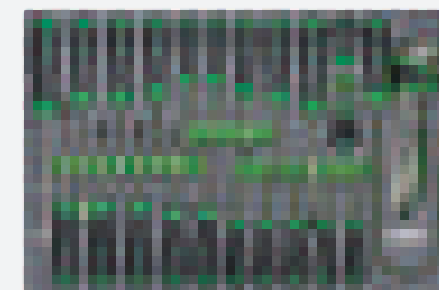

3RD DRAWER

GED3102



4TH DRAWER

GED1353

BUMPER SERIES

W/7-Drawer Tool Trolley - 213PCS Mechanical Tool Set

	CONTENTS	DESCRIPTION
1 ST	GEDD348	133 1/4" & 1/2" DR. Flank Socket Set
2 ND	GED3649	36 Combination, Double Open End & Double Ring Wrench Set
3 RD	GED3102	31 Screwdriver Set
4 TH	GED1353	13 Pliers & Hammer Set



• Smart foldable key



• Impact protection (Soft bumpers)

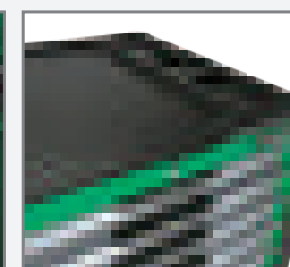

• Working platform in ABS, with 3 compartments for small parts

▶ Aluminum Torque Wrench

- Lightweight and robust aluminum alloy housing
- Rugged construction for all industrial applications and extreme continuous use
- Single square drive for controlled clockwise tightening
- Unique multi-lever mechanism ensures length independent and accurate torque.
- The torque output is the same from different grip position during fastening application
- Automatic tactile impulse and audible signal when desired torque is reached
- Easy and accurate torque setting through adjustment knob on the end of the handle
- Supplied with extension handles to minimize operator effort when higher torque is required
- Ideal for various industrial manufacturing areas such as industrial automation, wind power industry, aerospace industry and etc.
- Tolerance of torque accuracy $\pm 3\%$
- Tested and certified according to DIN EN ISO 6789, ASME B107.300 (ASME B107.14)



• Clear Window Scale Reading

• Easy Lock & Adjustment Design

ITEM NO.	DRIVE	CAPACITY	Aluminum Housing L(mm)	Overall Length W/Extension Tubes (mm)	📦
ANAQ32B0	1"	750-2000Nm	950	2350	1
ANAQ48C0	1-1/2"	1500-3000Nm	1050	2820	1

▶ 3PCS 1" DR. Torque Multiplier Set

- Specifically designed tool to remove and install wheel nuts for trucks and heavy duty vehicles
- Torque Multiplier is made of high grade Chrome Molybdenum Alloy Steel
- High-efficiency planetary gear sets achieve high output torque from low input torque
- Set includes one Torque Multiplier, Crank Handle and Extension Bar
- Suitable for 1" square drive sockets
- Maximum Output Torque: 3200Nm
- Gear Ratio: 1:56



• Easily remove highly torqued or stubborn wheel nuts

• Use the extension bar to quickly turn the nut

ITEM NO.	CONTENTS	📦
ANEE3232	1 Torque Multiplier 1" (M) x 1" (M) Output (Max.): 3200Nm / 2360Ft-Lb 1 Extension Bar 1 Crank Handle	2 (SET)

BLOW CASE: W370 x D200 x H130 (mm)

▶ Interchangeable Torque Handle

- Interchangeable open-end head is made of Chrome Vanadium Alloy Steel
- Positive lock with spring loaded pull-down lock ring for easy and quick torque adjustments
- The robust and fully chromed steel tube is ideal for various industrial applications
- Applied to calibrate in both clockwise and counterclockwise direction
- Quick release design for changing the inserted tools and accessories quickly
- Ergonomically designed, TPR material anti-slip handle
- Tolerance of torque accuracy $\pm 4\%$ CW and $\pm 4\%$ CCW
- Tested and certified according to DIN EN ISO 6789, ASME B107.300 (ASME B107.14)



ITEM NO.	HEAD SIZE (mm)	CAPACITY	L(mm)	📦
ANAP0160	14x18	100-600Nm	986	2
ANAP0180	14x18	150-800Nm	1172	2
ANAP01A0	14x18	200-1000Nm	1172	2

▶ Spanner Head (Open End)

- CR-V/CR-MO Steel Head
- Chrome plated finish



ITEM NO.	HEAD SIZE (mm)	SIZE (mm)	L (mm)	📦	📦
ANAK0307	9x12	7	37	25	100
ANAK0308	9x12	8	37	25	100
ANAK0309	9x12	9	38	25	100
ANAK0310	9x12	10	39	25	100
ANAK0311	9x12	11	39	25	100
ANAK0312	9x12	12	40	25	100
ANAK0313	9x12	13	42	25	100
ANAK0314	9x12	14	42	25	100
ANAK0315	9x12	15	42	20	80
ANAK0316	9x12	16	43	20	80

ITEM NO.	HEAD SIZE (mm)	SIZE (mm)	L (mm)	📦	📦
ANAK0317	9x12	17	43	20	80
ANAK0318	9x12	18	46	20	80
ANAK0319	9x12	19	46	20	80
ANAK0113	14x18	13	63	20	80
ANAK0114	14x18	14	63	20	80
ANAK0115	14x18	15	64	20	80
ANAK0116	14x18	16	64	20	80
ANAK0117	14x18	17	64	20	80
ANAK0118	14x18	18	65	20	80
ANAK0119	14x18	19	65	20	80
ANAK0121	14x18	21	66	10	40
ANAK0122	14x18	22	66	10	40
ANAK0124	14x18	24	67	10	40
ANAK0126	14x18	26	70	10	40
ANAK0127	14x18	27	70	10	40
ANAK0129	14x18	29	74	10	40
ANAK0130	14x18	30	74	10	40
ANAK0132	14x18	32	77	10	40
ANAK0134	14x18	34	82	10	40
ANAK0136	14x18	36	82	10	40
ANAK0138	14x18	38	82	10	40
ANAK0141	14x18	41	83	5	20
ANAK0146	14x18	46	86	5	20
ANAK0148	14x18	48	97	5	20
ANAK0150	14x18	50	97	5	20
ANAK0155	14x18	55	97	5	20

▶ Spanner Head (Ring End)

- CR-V/CR-MO Steel Head
- Chrome plated finish



ITEM NO.	HEAD SIZE (mm)	SIZE (mm)	L (mm)	📦	📦
ANAR0307	9x12	7	42	20	80
ANAR0308	9x12	8	42	20	80
ANAR0309	9x12	9	44	20	80
ANAR0310	9x12	10	45	20	80

ITEM NO.	HEAD SIZE (mm)	SIZE (mm)	L (mm)	📦	📦
ANAR0311	9x12	11	45	20	80
ANAR0312	9x12	12	46	20	80
ANAR0313	9x12	13	49	20	80
ANAR0314	9x12	14	50	20	80
ANAR0113	14x18	13	70	20	80
ANAR0114	14x18	14	70	20	80
ANAR0115	14x18	15	70	20	80
ANAR0116	14x18	16	73	20	80
ANAR0117	14x18	17	73	20	80
ANAR0119	14x18	19	75	15	60
ANAR0122	14x18	22	77	10	40
ANAR0124	14x18	24	78	10	40
ANAR0126	14x18	26	78	10	40
ANAR0127	14x18	27	82	10	40
ANAR0129	14x18	29	85	10	40
ANAR0130	14x18	30	87	10	40
ANAR0132	14x18	32	87	10	40
ANAR0134	14x18	34	82	10	40
ANAR0136	14x18	36	82	10	40
ANAR0141	14x18	41	85	10	40

▶ **16PCS 1/4", 3/8" & 1/2" DR. Torx Plus® EPR Socket Set**

- Made of drop forged Chrome Vanadium Alloy Steel
- Set includes 16pcs Torx Plus® EPR (5 sided) sockets, from 6EPR to 32EPR
- Supplied in EVA form storage tray



CR-V

ITEM NO.	CONTENTS	10 (SET)
GABF1601	5 1/4" Dr. Torx Plus® EPR Sockets (25mmL) 6EPR, 7EPR, 8EPR, 10EPR, 11EPR 5 3/8" Dr. Torx Plus® EPR Sockets (37mmL) 12EPR, 14EPR, 16EPR, 18EPR, 20EPR 6 1/2" Dr. Torx Plus® EPR Sockets (45mmL) 22EPR, 24EPR, 26EPR, 28EPR, 30EPR, 32EPR	

Satin Chrome Finished

▶ **Flexible Reversible Ratchet Handle with Quick Release**

DIN 3122



30 Gears / Satin Chrome Finished

DRIVE	ITEM NO.	L(mm)	5	40
3/8"	CJHO1228	280		

▶ **12PT Flexible Universal Sockets**

CR-V ASME B107.110 DIN 3124



Satin Chrome Finished

DRIVE	ITEM NO.	SIZE(inch)	L(mm)	20	360
1/4"	BBAL0808	1/4	35	20	360
	BBAL0810	5/16	35	20	360
	BBAL0812	3/8	36	20	320
	BBAL0814	7/16	38	20	320
	BBAL0816	1/2	40	20	320
	BBAL0818	9/16	40	20	320
3/8"	BBAL1208	1/4	48	10	160
	BBAL1210	5/16	48	10	160
	BBAL1212	3/8	50	10	160
	BBAL1214	7/16	51	10	160
	BBAL1216	1/2	52	10	160
	BBAL1218	9/16	52	10	160
10mm sq.	BBAL1220	5/8	55	10	160
	BBAL1222	11/16	56	10	100
	BBAL1224	3/4	58	10	100

▶ **Reversible Ratchet Handle with Quick Release**

DIN 3122



24 Gears / Satin Chrome Finished

DRIVE	ITEM NO.	L(mm)	5	30
1/2"	CJBC1627	270		

▶ **Swivel Handle (Knurled Grip)**

DIN 3122



Satin Finished

DRIVE	ITEM NO.	L(inch)	10	80
1/4"	CFAE0806	6		
3/8"	CFAE1210	10	5	40
1/2"	CFAE1615	15	5	20
	CFAE1618	18	5	25



▶ **144PCS 1/4", 3/8" & 1/2" DR. Flank Socket Wrench Set**

1/4"

3/8"

1/2"



- Professional quality meets or exceeds both ANSI & DIN standards
- High-Strength S2 Steel bit sockets feature quality workmanship and value
- Rugged blow molded case for perfect tool protection and storage



BLOW CASE:
W560 x D412 x H120 (mm)

DIN ANSI CR-V (Chrome Vanadium Steel) S2 (High Speed Steel)

Satin Chrome Finished

ITEM NO.	6PT	Satin	GCAI144R	2 (SET)
CONTENTS				
9 BAEA0804-0810	1/4" Dr. 6PT Flank Sockets - 4, 4.5, 5, 5.5, 6, 7, 8, 9, 10 mm			
15 BAEB1206-1222	3/8" Dr. 12PT Flank Sockets - 6, 7, 8, 9, 10, 11, 12, 13, 14, 15, 17, 18, 19, 21, 22 mm			
19 BAEA1608-1632	1/2" Dr. 6PT Flank Sockets - 8, 10, 12, 13, 14, 15, 16, 17, 18, 19, 20, 21, 22, 23, 24, 25, 27, 30, 32 mm			
2 BAAR1616 & 1621	1/2" Dr. Spark Plug Sockets - 16 & 21 mm			
5 BAED0804-0808	1/4" Dr. Star Sockets - E4, E5, E6, E7, E8			
5 BAED1610-1620	1/2" Dr. Star Sockets - E10, E12, E14, E16, E20			
1 CJBG0815	1/4" Dr. 36 Teeth Reversible Ratchet Handle with Quick Release			
1 CJHO1228	3/8" Dr. 30 Teeth Flexible Reversible Ratchet Handle with Quick Release			
1 CJBC1627	1/2" Dr. 24 Teeth Reversible Ratchet Handle with Quick Release			
1 CFAE1618	1/2" Dr. Swivel Handle - 18" (L)			
1 AFAN1610	1/2" Dr. L-Handle (90° Offset) - 10" (L)			
3 CAAA0802-0806	1/4" Dr. Extension Bar - 2", 4", 6" (L)			
2 CAAA1203 & 1206	3/8" Dr. Extension Bar - 3" & 6" (L)			
2 CAAA1603 & 1610	1/2" Dr. Extension Bar - 3" & 10" (L)			
1 CASA0806	1/4" Dr. Flexible Extension Bar - 6" (L)			
1 CAGA1208	3/8" (F) x 1/4" (M) Dr. 3-Way Adapter			
1 CAGA1216	3/8" (F) x 1/2" (M) Dr. 3-Way Adapter			
3 CAHA0840-1678	1/4", 3/8" & 1/2" Dr. Universal Joint			
1 CAIP0816	1/4" Dr. Spinner Handle			

CONTENTS
17 AAEX0606-2424
Hi-Performance Combination Wrench 15" Offset - 6, 7, 8, 9, 10, 11, 12, 13, 14, 15, 16, 17, 18, 19, 21, 22, 24 mm
5 AEEA0810-1719
Flare Nut Wrenches - 8x10, 10x12, 11x13, 12x14, 17x19 mm
9 GSN-09SH
Short Type Hex Key Wrench Set - 1.5, 2, 2.5, 3, 4, 5, 6, 8, 10 mm
1 DBBB2207
Combination Pliers - 7" (L)
1 DAAQ1A10
Curved Jaw Locking Pliers with Wire Cutter - 10" (L)
1 FAAF5E10
Slotted Anti-Slip Screwdrivers - 5.5x100
1 FABF6E03
Stubby Slotted Anti-Slip Screwdriver - 6.5x25
1 FAGF6E15
Go-Thru Slotted Screwdriver - 6.5x150
1 FBAF0108
Phillips Anti-Slip Screwdriver - PH1x80
1 FBBF0203
Stubby Phillips Anti-Slip Screwdriver - PH2x25
1 FBGF0210
Go-Thru Phillips Screwdriver - PH2x100
4 FSAA0804-0808
1/4" Hex Shank Slotted Insert Bits - 4, 5.5, 6.5, 8 mm
4 FSBA0800-0803
1/4" Hex Shank Phillips Insert Bits - PH0, PH1, PH2, PH3
4 FSCA0800-0803
1/4" Hex Shank Pozi Insert Bits - PZ0, PZ1, PZ2, PZ3
9 FSDA0802-0812
1/4" Hex Shank Hexagon Insert Bits - 2, 3, 4, 5, 6, 7, 8, 10, 12 mm
7 FSGA0810-0840
1/4" Hex Shank Star Tamperproof Insert Bits - T10, T15, T20, T25, T27, T30, T40
1 FTAB0808
1/4" Dr. x 1/4" (H) Quick Change Bit Holder
1 HAAA0330
Engineers Hammer (300g)
1 IAAC1903M
Heavy Duty Metric Measuring Tape - 3M

BLOW CASE: W560 x D412 x H120 (mm)

Pro-Plus Series Anti-Slip Screwdrivers

- Specially hardened and tempered steel material provides "High Strength" blade performance
- The hexagonal anti-roll feature prevents any bothersome rolling away at the workplace
- Hang-up hole design for convenient storage or for use with a fall protection wire
- The green resistant plastic is used for the core and ensures the blade is held securely.
- Well-sized slim spinning area at the end of the handle guarantees fast turning
- Head marking for specifically and rapidly accessing the right screwdriver
- Black hardened magnetic tip assures long service life and perfectly hold the screw head in place
- The hexagonal shaft allows tightening with an open ended spanner for extra torque if needed
- The soft black material zones provide optimum grip and ensure high torque transfer
- Striking cap helps loosen seized screws by gently knocking on the striking cap
- Hardened and precision machined magnetic tip
- Hex shaft design for increasing torque ability
- Go thru blade with striking cap

The direct connection of the solid striking cap to the blade ensures the impact energy is transmitted without any loss

6PCS Pro-Plus Series Go-Thru Slotted & Phillips Screwdriver Set (Hexagon Steel & Bolster)



ITEM NO.	CONTENTS	20 (SET)
GFE-0602	<ul style="list-style-type: none"> 4 FAGF5E10-1020 Pro-Plus Series Go-Thru Slotted Screwdrivers (Hexagon Steel & Bolster) 5.5x100, 6.5x150, 8x175, 10x200 2 FBGF0108 & 0210 Pro-Plus Series Go-Thru Phillips Screwdrivers (Hexagon Steel & Bolster) PH1x75 & PH2x100 	

5PCS Pro-Plus Series Slotted & Phillips Super-Grip Screwdriver Set

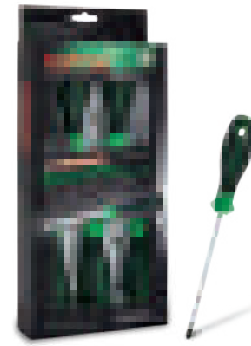

ITEM NO.	CONTENTS	20 (SET)
GFE-0501	<ul style="list-style-type: none"> 3 FAAF5E10-0818 Pro-Plus Series Slotted Anti-Slip Screwdrivers 5.5x100, 6.5x150, 8x175 2 FBAF0108 & 0210 Pro-Plus Series Phillips Anti-Slip Screwdrivers PH1x80 & PH2x100 	

8PCS Pro-Plus Series Slotted & Phillips Super-Grip Screwdriver Set



ITEM NO.	CONTENTS	20 (SET)
GFE-0801	<ul style="list-style-type: none"> 5 FAAF3E10-0818 Pro-Plus Series Slotted Anti-Slip Screwdrivers 3.5x100, 4x100, 5.5x100, 6.5x150, 8x175 3 FBAF0006-0210 Pro-Plus Series Phillips Anti-Slip Screwdrivers PH0x60, PH1x80, PH2x100 	

6PCS Pro-Plus Series Star Tamperproof Super-Grip Screwdriver Set



ITEM NO.	CONTENTS	20 (SET)
GFE-0603	<ul style="list-style-type: none"> 6 FEAF1008-4015 Pro-Plus Series Star Tamperproof Anti-Slip Screwdrivers T10x75, T15x75, T20x100, T25x100, T30x125, T40x150 	

6PCS Pro-Plus Series Slotted & Phillips Super-Grip Screwdriver Set



ITEM NO.	CONTENTS	20 (SET)
GFE-0601	<ul style="list-style-type: none"> 3 FAAF0410-1020 Pro-Plus Series Slotted Anti-Slip Screwdrivers 4x100, 6.5x150, 10x200 3 FBAF0108-0315 Pro-Plus Series Phillips Anti-Slip Screwdrivers PH1x80, PH2x100, PH3x150 	

11PCS Pro-Plus Series Slotted & Phillips Super-Grip Screwdriver Set



ITEM NO.	CONTENTS	10 (SET)
GFE-1101	<ul style="list-style-type: none"> 7 FAAF0308-1020 Pro-Plus Series Slotted Anti-Slip Screwdrivers 3x75, 3.5x100, 4x100, 5.5x100, 6.5x150, 8x175, 10x200 4 FBAF0006-0315 Pro-Plus Series Phillips Anti-Slip Screwdrivers PH0x60, PH1x80, PH2x100, PH3x150 	

6PCS Pro-Plus Series Star Super-Grip Screwdriver Set



ITEM NO.	CONTENTS	20 (SET)
GFE-0604	<ul style="list-style-type: none"> 6 FFAF1008-3013 Pro-Plus Series Star Anti-Slip Screwdrivers T10x75, T15x75, T20x100, T25x100, T27x100, T30x125 	

Pro-Plus Series
Stubby Slotted Anti-Slip Screwdrivers

- Manufacturing according to DIN ISO 2380-1, DIN ISO 2380-2
- Expert quality, specially hardened and tempered SNCM+V steel round blade
- Short round blade and ball handle for use in confined spaces
- High performance black hardened, magnetic tip
- Imprinted screw profile at end of the handle for quick accessing the right screwdriver
- Ergonomically shaped, bi-component PP+TPR grip handle for maximum power transmission
- Hang-up hole design for convenient storage or for use with a fall protection wire

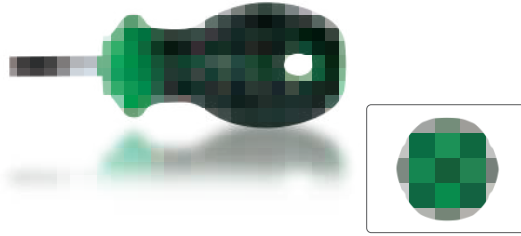

TYPE	ITEM NO.	Blade Width (mm)	Blade Thickness (mm)	L1 (mm)	L (mm)	Weight (g)	Box Qty
⊖	FABF0403	4	0.8	25	90	5	80
⊖	FABF5E03	5.5	1.0	25	90	5	80
⊖	FABF6E03	6.5	1.2	25	90	5	80

Pro-Plus Series
Slotted Anti-Slip Screwdrivers

- Manufacturing according to DIN ISO 2380-1, DIN ISO 2380-2
- Expert quality, specially hardened and tempered SNCM+V steel round blade
- High performance black hardened, magnetic tip
- Imprinted screw profile at end of the handle for quick accessing the right screwdriver
- Ergonomically shaped, bi-component PP+TPR grip handle for maximum power transmission
- Hang-up hole design for convenient storage or for use with a fall protection wire



TYPE	ITEM NO.	Blade Width (mm)	Blade Thickness (mm)	L1 (mm)	L (mm)	Weight (g)	Box Qty
⊖	FAAF0308	3	0.5	75	169	5	40
⊖	FAAF3E10	3.5	0.6	100	194	5	40
⊖	FAAF0410	4	0.8	100	202	5	40
⊖	FAAF0510	5	0.8	100	202	5	40
⊖	FAAF5E10	5.5	1.0	100	213	5	40
⊖	FAAF5E15	5.5	1.0	150	263	5	40
⊖	FAAF6E10	6.5	1.2	100	213	5	40
⊖	FAAF6E15	6.5	1.2	150	263	5	30
⊖	FAAF6E20	6.5	1.2	200	313	5	30
⊖	FAAF0818	8	1.2	175	295	5	30
⊖	FAAF1020	10	1.6	200	320	5	30

Pro-Plus Series
Stubby Phillips Anti-Slip Screwdrivers

- Manufacturing according to DIN ISO 8764-1, DIN ISO 8764-2
- Expert quality, specially hardened and tempered SNCM+V steel round blade
- Short round blade and ball handle for use in confined spaces
- High performance black hardened, magnetic tip
- Imprinted screw profile at end of the handle for quick accessing the right screwdriver
- Ergonomically shaped, bi-component PP+TPR grip handle for maximum power transmission
- Hang-up hole design for convenient storage or for use with a fall protection wire

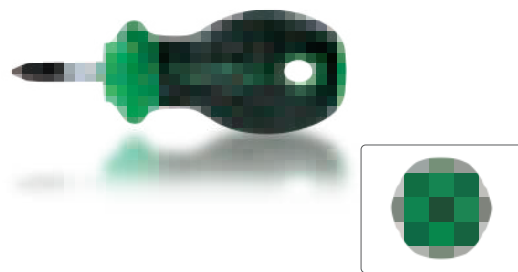

TYPE	ITEM NO.	SIZE	L1 (mm)	L (mm)	Weight (g)	Box Qty
⊕	FBBF0103	PH1	25	90	5	80
⊕	FBBF0203	PH2	25	90	5	80

Pro-Plus Series
Phillips Anti-Slip Screwdrivers

- Manufacturing according to DIN ISO 8764-1, DIN ISO 8764-2
- Expert quality, specially hardened and tempered SNCM+V steel round blade
- High performance black hardened, magnetic tip
- Imprinted screw profile at end of the handle for quick accessing the right screwdriver
- Ergonomically shaped, bi-component PP+TPR grip handle for maximum power transmission
- Hang-up hole design for convenient storage or for use with a fall protection wire

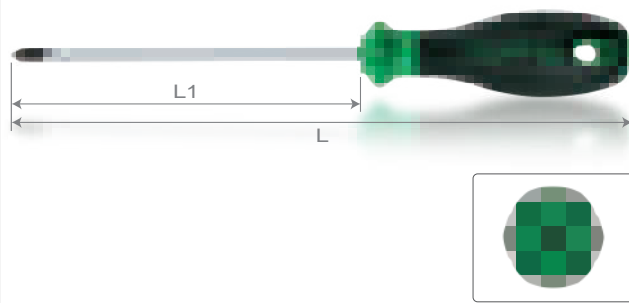

TYPE	ITEM NO.	SIZE	L1 (mm)	L (mm)	Weight (g)	Box Qty
⊕	FBAF0006	PH0	60	154	5	40
⊕	FBAF0108	PH1	80	182	5	40
⊕	FBAF0110	PH1	100	202	5	40
⊕	FBAF0210	PH2	100	213	5	40
⊕	FBAF0215	PH2	150	263	5	30
⊕	FBAF0220	PH2	200	313	5	30
⊕	FBAF0315	PH3	150	270	5	30

Pro-Plus Series
Star Anti-Slip Screwdrivers

- Expert quality, specially hardened and tempered S2 alloy steel round blade
- High performance black hardened, magnetic tip
- Imprinted screw profile at end of the handle for quick accessing the right screwdriver
- Ergonomically shaped, bi-component PP+TPR grip handle for maximum power transmission
- Hang-up hole design for convenient storage or for use with a fall protection wire

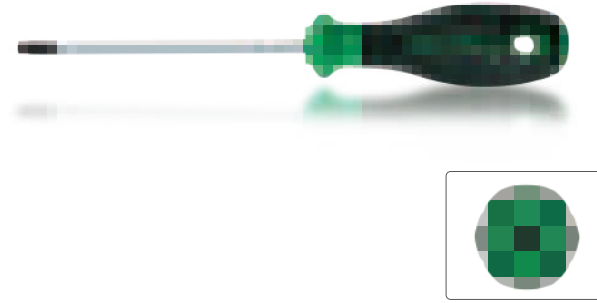

TYPE	ITEM NO.	SIZE	L1 (mm)	L (mm)	Weight (g)	Box Qty
⊙	FFAF1008	T10	75	169	5	40
⊙	FFAF1508	T15	75	177	5	40
⊙	FFAF2010	T20	100	202	5	40
⊙	FFAF2510	T25	100	202	5	40
⊙	FFAF2710	T27	100	213	5	40
⊙	FFAF3013	T30	125	238	5	40
⊙	FFAF4015	T40	150	270	5	30

Pro-Plus Series
Go-Thru Slotted Screwdrivers (Hexagon Steel & Bolster)

- Manufacturing according to DIN ISO 2380-1, DIN ISO 2380-2
- Expert quality, specially hardened and tempered SNCM+V steel hexagonal blade
- Integrated hex shoulder for use with a wrench to transfer higher torque
- Steel striking impact cap enables shockwave unlock rusted fasteners for easier unfastening
- High performance black hardened, magnetic tip
- Ergonomically shaped, bi-component PP+TPR grip handle for maximum power transmission

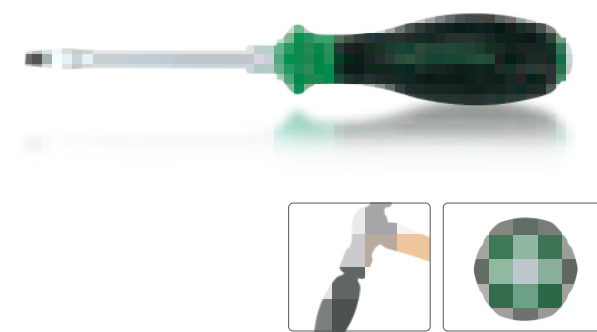

TYPE	ITEM NO.	Blade Width (mm)	Blade Thickness (mm)	L1 (mm)	L (mm)	Weight (g)	Box Qty
⊖	FAGF5E10	5.5	1.0	100	213	5	40
⊖	FAGF6E15	6.5	1.2	150	263	5	30
⊖	FAGF0818	8	1.2	175	295	5	30
⊖	FAGF1020	10	1.6	200	320	5	30

Pro-Plus Series
Star Tamperproof Anti-Slip Screwdrivers

- Expert quality, specially hardened and tempered S2 alloy steel round blade
- High performance black hardened, magnetic tip
- Imprinted screw profile at end of the handle for quick accessing the right screwdriver
- Ergonomically shaped, bi-component PP+TPR grip handle for maximum power transmission
- Hang-up hole design for convenient storage or for use with a fall protection wire



TYPE	ITEM NO.	SIZE	L1 (mm)	L (mm)	Weight (g)	Box Qty
⊙	FEAF1008	T10	75	169	5	40
⊙	FEAF1508	T15	75	177	5	40
⊙	FEAF2010	T20	100	202	5	40
⊙	FEAF2510	T25	100	202	5	40
⊙	FEAF2710	T27	100	213	5	40
⊙	FEAF3013	T30	125	238	5	40
⊙	FEAF4015	T40	150	270	5	30

Pro-Plus Series
Go-Thru Phillips Screwdrivers (Hexagon Steel & Bolster)

- Manufacturing according to DIN ISO 8764-1, DIN ISO 8764-2
- Expert quality, specially hardened and tempered SNCM+V steel hexagonal blade
- Integrated hex shoulder for use with a wrench to transfer higher torque
- Steel striking impact cap enables shockwave unlock rusted fasteners for easier unfastening
- High performance black hardened, magnetic tip
- Ergonomically shaped, bi-component PP+TPR grip handle for maximum power transmission

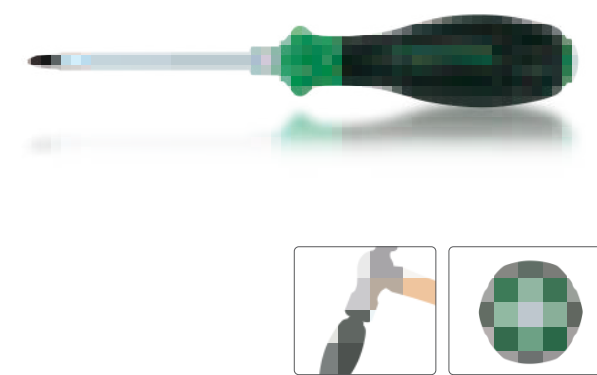

TYPE	ITEM NO.	SIZE	L1 (mm)	L (mm)	Weight (g)	Box Qty
⊕	FBGF0108	PH1	75	188	5	40
⊕	FBGF0210	PH2	100	213	5	40
⊕	FBGF0315	PH3	150	270	5	30

▶ **40PCS 1/4" Hex Drive Screwdriver Bit Set**

1/4"

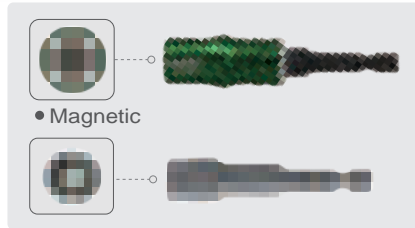

ITEM NO.	CONTENTS	10 (SET)	20 (SET)
GAEW4001	4 FSAA0803-086E		
	1/4" Hex Shank Slotted Insert Bits - 3, 4, 5.5, 6.5 mm		
	6 FSBA0801-0803		
	1/4" Hex Shank Phillips Insert Bits - PH1x2pcs, PH2x3pcs, PH3		
	4 FSCA0801-0803		
	1/4" Hex Shank Pozi Insert Bits - PZ1, PZ2x2pcs, PZ3		
	4 FSDA0803-0806		
	1/4" Hex Shank Hexagon Insert Bits - 3, 4, 5, 6 mm		
	9 FSEA0810-0840		
	1/4" Hex Shank Star Insert Bits T10, T15, T20x2pcs, T25x2pcs, T27, T30, T40		
	4 FSIA0801-0803		
	1/4" Hex Shank Phillips Power Screwdriver Bits PH1, PH2x2pcs, PH3		
	1 FSRA0802		
	1/4" Hex Shank Pozi Power Screwdriver Bits - PZ2		
	4 FSSA0820 & 0825		
1/4" Hex Shank Star Power Screwdriver Bits - T20x2pcs, T25x2pcs			
1 BEAA0806-0810			
1/4" Hex Shank Magnetic Power Nut Setter - 6, 8, 10 mm			
1 FTGB0807			
1/4" x 1/4" Quick Change Magnetic Bit Holder			

PLASTIC BOX: W150 x D98 x H45 (mm)

▶ **60PCS 3/8" & 1/2" DR. Professional Bit Set**

3/8"
1/2"



SCM-V CR-V

ITEM NO.	CONTENTS	6 (SET)
GCAI6003	9 10mm Hex Shank Star Insert Bits (L=30mm) T20, T25, T27, T30, T40, T45, T50, T55, T60	
	5 10mm Hex Shank Spline Insert Bits (L=30mm) M5, M6, M8, M10, M12	
	7 10mm Hex Shank Hexagon Insert Bits (L=30mm) 4, 5, 6, 7, 8, 10, 12 mm	
	2 14mm Hex Shank Hexagon Insert Bits (L=30mm) 14 & 17 mm	
	5 10mm Hex Shank Ribe Insert Bits (L=74mm) M6, M7, M8, M10, M12	
	6 10mm Hex Shank Spline Insert Bits (L=74mm) M5, M6, M8, M9, M10, M12	
	9 10mm Hex Shank Hexagon Insert Bits (L=74mm) 4, 5, 6, 7, 8, 9, 9.5(3/8"), 10, 12 mm	
	9 10mm Hex Shank Star Insert Bits (L=74mm) T20, T25, T27, T30, T40, T45, T50, T55, T60	
	2 10mm Hex Shank Square Insert Bits (L=74mm) 8 & 10 mm	
	1 14mm Hex Shank Spline Insert Bits (L=74mm) M14	
	1 14mm Hex Shank Tamper Spline Insert Bits (L=74mm) M16	
	3 Quick Change Bit Holders 1/2" Dr. x 10mm (H) 3/8" Dr. x 10mm (H) 1/2" Dr. x 14mm (H)	
	1 Buffer Adapter 14mm x 10mm	

BLOW CASE: W330 x D260 x H55 (mm)

NEW PRO-LINE SERIES

▶ **Mobile Workstation**

NEW PRO-LINE SERIES GRAY

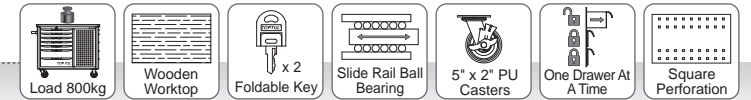

- Heavy duty construction workstation with large storage capacity
- 6 medium & 6 large drawers with central locking system
- Smooth ball bearing slide drawers with auto-return function (full 100% retractable drawers)
- Safety lock allows only one drawer is opened at a time (preventing the cabinet to tip over)
- Loading capacity per drawer 45 kg
- Loading capacity per shelf 25 kg
- Static load capacity 800 kg
- Solid 40mm thick wood worktop with a safe working load capacity of 200 kg (evenly distributed)
- New style composite drawer handle
- Strong side handle
- Smart foldable key
- Electro-powder coating to resist scratches & solvent markings
- Heavy duty 5" x 2" PU casters with locks (2 fixed casters & 2 swivel casters with locks)
- Supplied with drawer liners, one spray can holder, one paper roll holder and two shelves

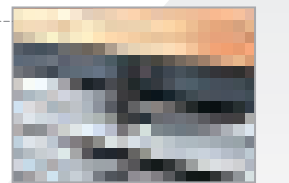

Mobile Workstation

ITEM NO.	SIZE(W)x(D)x(H)mm
TCDB1203	Overall: 1208x771x845 Overall w/caster: 1208x771x1009 6 Drawer: 578x378x75 6 Drawer: 578x378x155

NEW PRO-LINE



▶ **Digital Vehicle Battery Tester**

- Specially designed for testing 12 volt vehicle batteries, starting system and charging system
- Suitable for Lead-Acid Battery (Sealed Maintenance Free Battery, Maintenance Free Battery, Standard Type Battery), EFB Battery, AGM Battery
- Quickly obtains the test result by keying in the rated value (CCA/CA) of the battery
- Easy to read illuminated LCD display
- 0.85 meter long cable allows for flexible work

Function:

- (1) Battery Voltage Measurement
- (2) Battery Test - CCA*SAE, CCA*DIN, CCA*EN, CCA*IEC, CA (MCA)
- (3) Engine Start Voltage Measurement
- (4) Charging Voltage Measurement

ITEM NO.	EAAD0112	
SPECIFICATIONS  30		
Rated Battery Voltage	12V	
Rating Systems	SAE, DIN, EN, IEC, CA	
Battery Test Ranges	CCA*SAE	200~950A
	CCA*DIN	105~600A
	CCA*EN	185~900A
	CCA*IEC	125~710A
	CA (MCA)	250~1190A
Voltage Range	9~15V	
Operating Temperature	0~50°C (32~122°F)	
Storage Temperature	-30~70°C (-22~158°F)	
Dimension	135mm(L)x80mm(W)x35mm(H)	
Weight	Approx. 330g	



▶ **DIGITAL VEHICLE BATTERY TESTER**



VDE Insulated

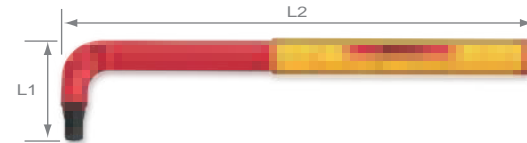

▶ **VDE Insulated Extra Long Type Hex Key Wrench**

- High strength, specially hardened and tempered S2 alloy steel
- Multi-layer PP+TPR lining fully insulation grip
- Insulation tested and certified to VDE and international standard DIN EN/IEC 60900
- Suitable for safety working on and around live power up to 1000V AC
- Perfect for working on hybrid and electrical vehicles





ITEM NO.	SIZE (mm)	L1 (mm)	L2 (mm)		
AGAE2E13V4	2.5	24	134	30	240
AGAE0313V4	3	24	134	30	240
AGAE0417V4	4	35	170	15	240
AGAE0517V4	5	35	170	15	240
AGAE0622V4	6	46	215	10	80
AGAE0822V4	8	46	215	10	80

▶ **VDE Insulated Extra Long Type Star Key Wrench**

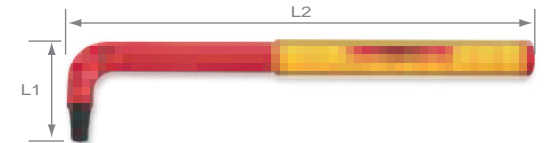
- High strength, specially hardened and tempered S2 alloy steel
- Multi-layer PP+TPR lining fully insulation grip
- Insulation tested and certified to VDE and international standard DIN EN/IEC 60900
- Suitable for safety working on and around live power up to 1000V AC
- Perfect for working on hybrid and electrical vehicles



ITEM NO.	SIZE	L1 (mm)	L2 (mm)		
AIAE1013V4	T10	24	134	30	240
AIAE1513V4	T15	24	134	30	240
AIAE2017V4	T20	35	170	15	240
AIAE2517V4	T25	35	170	15	240
AIAE2717V4	T27	35	170	15	240
AIAE3017V4	T30	35	170	15	240
AIAE4022V4	T40	46	215	10	80
AIAE4522V4	T45	46	215	10	80
AIAE5022V4	T50	46	215	10	80

▶ **6PCS VDE Insulated Extra Long Type Hex Key Wrench Set**



ITEM NO.	Insulated	GZA0648	 6 (SET)
CONTENTS			
6 AGAE2E13V4~0822V4 VDE Insulated Extra Long Type Hex Key Wrenches 2.5, 3, 4, 5, 6, 8 mm			
PLASTIC BOX: W373 x D143 x H56 (mm)			

▶ **9PCS VDE Insulated Extra Long Type Star Key Wrench Set**



ITEM NO.	Insulated	GZC0911	 5 (SET)
CONTENTS			
9 AIAE1013V4~5022V4 VDE Insulated Extra Long Type Star Key Wrenches T10, T15, T20, T25, T27, T30, T40, T45, T50			
PLASTIC BOX: W373 x D289 x H56 (mm)			

▶ **VDE Insulated Single Open End Wrench**

- Chrome Vanadium Steel Material
- High quality multi-layer TPR lining insulation
- Insulation meets VDE and international standard DIN EN/IEC 60900
- Safely working on and around live power up to 1000V AC
- Suitable for work on solar batteries and electric vehicles
- 15° Offset head design provides better leverage and allows to reach into different confined spaces



METRIC 1000V IEC 60900

ITEM NO.	SIZE (mm)	L (mm)		
AAAT0808V4	8	105	10	160
AAAT0909V4	9	105	10	160
AAAT1010V4	10	115	10	160
AAAT1111V4	11	125	10	160
AAAT1212V4	12	125	10	160
AAAT1313V4	13	155	10	160
AAAT1414V4	14	155	10	160
AAAT1515V4	15	170	5	80
AAAT1616V4	16	170	5	80
AAAT1717V4	17	170	5	80
AAAT1818V4	18	180	5	80
AAAT1919V4	19	180	5	80
AAAT2121V4	21	200	5	40
AAAT2222V4	22	200	5	40
AAAT2424V4	24	235	3	24

▶ **VDE Insulated Single Ring Wrench 75° Offset**

- Chrome Vanadium Steel Material
- High quality multi-layer TPR lining insulation
- Insulation meets VDE and international standard DIN EN/IEC 60900
- Safely working on and around live power up to 1000V AC
- Suitable for work on solar batteries and electric vehicles
- 75° offset ring end in design for operating easily in recess



METRIC 1000V IEC 60900

ITEM NO.	SIZE (mm)	L (mm)		
AAAW0808V4	8	165	10	160
AAAW0909V4	9	165	10	160
AAAW1010V4	10	175	5	80
AAAW1111V4	11	185	5	80
AAAW1212V4	12	185	5	80
AAAW1313V4	13	205	5	40
AAAW1414V4	14	205	5	40
AAAW1515V4	15	215	5	40
AAAW1616V4	16	220	5	40
AAAW1717V4	17	220	5	40
AAAW1818V4	18	235	5	40
AAAW1919V4	19	235	5	40
AAAW2121V4	21	255	5	40
AAAW2222V4	22	255	3	24
AAAW2424V4	24	285	3	24

▶ **90° Long Retaining Ring Pliers (Internal Ring)**

- Special designed pliers to remove and install internal ring in the deep spot
- 90° angled extra long slim tip for easy access to snap ring
- Drop forged, specially hardened and tempered tool steel body
- Spring-assisted opening for internal ring
- Non-slip, comfort plastic coating handles
- Tip diameter: Ø1.2mm

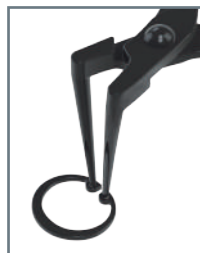

For internal ring, 19 to 60 mm diameter



Special designed to remove and install internal ring in the deep hole



ITEM NO.	SIZE (inch)	CAPACITY (Ø)		
DCBJ1307	7	19-60mm	12	48

▶ **Electronics Diagonal Cutting Pliers**

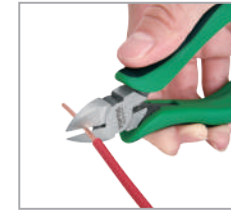

- High grade special tool steel material
- Induction hardened & precision machined cutting edges
- Spring-loaded return for quick repetitive opening
- Short Jaws and beveled cutting edges permit close cutting of wire
- Max. Cutting Capacity (Diam.): Ø2.0mm copper or similar soft wire
- Ergonomically designed TPR plastic grip handle
- Manufacturing according to DIN ISO 9654



ITEM NO.	SIZE (inch)	MAX. CAPACITY			
		Ø (mm)			
DEBD224E	4.5	2.0		6	120

▶ **Multifunctional Pliers**

- Multifunctional pliers with crimping, stripping and copper cable cutting functions
- Smooth gripping surface near the tips without damaging material
- Serrated gripping surfaces and pipe grip for gripping flat and round material
- Clear-cut outside edge for deburring and widening holes
- Safety lock keeps pliers securely closed when not in use
- Spring-loaded mechanism provides quick self-opening action



• Looping wires



• Crimping of conductor end-sleeves



• Cut flat and round copper cable



• Wire stripper



ITEM NO.	SIZE (inch)	Crimping Capacity (mm²)	Stripping Capacity (mm²)	Cutting Cables			
				Ø (mm)	(mm²)		
DFBG2208	8	0.5-2.5	0.7-1.5/2.5	15	50	10	40

▶ **Slip Joint Pliers**

- Chrome Vanadium Steel Material
- High precision milling smooth jaws for extra grip and ease of handling
- Serrated and accurately machined jaws provide a firm grip on the objects



- Non-slip clamping jaws
- Round tube, bolt screw clamping hole
- Wire shear
- 2-positions adjustment jaws

- Comfort non-slip grip handle
- Manufacturing according to ASME B107.500

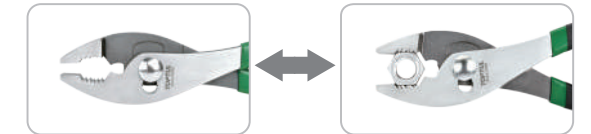
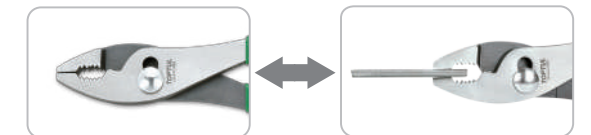

ITEM NO.	SIZE (inch)		
DHAA1208B	8	10	40

▶ Refill Pressure Sprayer



- Ideal for refilling lubricants, brake system cleaners, anti-rust liquid and etc.
- Two-position adjustable folding nozzle. Standard nozzle is suitable for wide spray and long nozzle needle is especially suitable for narrow and hard to reach areas
- Pressurized via standard Schrader valve
- Fitted with automatic safety release valve pre-set at 90PSI (6.2BAR) prevents applying excessive pressure
- Provides output of fluid or air even when held upside down, spray from any angles without the limitation of space
- Aluminum canister for long service life
- Max. Working Pressure: 90PSI / 6.2BAR
- Max. Capacity: 650 ml / c.c.
- Filling Capacity: 50 - 350 ml / c.c.



• Spray from any angles without the limitation of space

- Two type nozzles for both wide range mist and specific spot stream spraying

ITEM NO.	MAX. CAPACITY	SIZE D×L(mm)	📦
NDA0165	650 ml / c.c	65x280	12

▶ Piston Grip Grease Gun - W/7" Rigid Tube



- 4-Jaw Coupler for Better Grip
- Max. Working Pressure: 2,900PSI (200BAR)
- Burst Pressure: 4,000PSI (275BAR)
- Electroplating finishing for long service life
- Easy to use with one hand
- Short stroke piston grip action works great in tight spaces
- Two discharge outlets - 90° & 180°
- Use standard 3 oz. grease cartridge

ITEM NO.	CAPACITY	📦
JJBA0302	Standard 3 oz. Cartridge Bulk 120 c.c. , L=10-1/4" (260mm)	30

▶ Pipe Wrench (90° Swedish Model)

- Swedish pattern pipe wrench
- Made of drop forged Chrome Vanadium Steel
- 90° offset teeth against direction of rotation
- Knurled nut for quick adjustment of the jaw width
- Suitable for grip, rotation or bolting of round, multi-edged pipes, nuts, and flanges

DIN 5234



ITEM NO.	SIZE (inch)	JAW OPENING CAPACITY Ø (inch)	L (mm)	📦	📦
DDAF1A32	1	1-1/2	335	2	12
DDAF1A48	1-1/2	2-1/4	440	2	12
DDAF1A64	2	2-1/2	555	2	8

▶ 8PCS Basin Wrench Set

- Designed for tightening and loosening the nut of faucet or hand basin in difficult-to-reach locations
- Hollow tube design allows threaded rods to go through
- Direction of rotation reversed by pivoting the jaw without removing adjustable jaw from the tool



ITEM NO.	CONTENTS	📦	📦
GNBA0801	1 Basin Wrench (13mm) 1 Adapter (9mm) 1 Adapter (10mm) 1 Adapter (11mm) 1 Adapter (12mm) 1 Adapter (14mm) 1 Adapter (17mm) 1 Adjustable Jaw (13-32mm)	8 (SET)	32 (SET)

▶ Stainless Steel Vernier Caliper

- Made of hardened and tempered Stainless Steel
- Accuracy: ±0.02 mm
- Graduations: 0.02 mm / 0.001 inch
- Measuring bar in both metric and imperial measurement

- Easy to read clear black engraved graduations
- For inside, outside, step and depth measurements
- Lock screw for sliding jaw
- Supplied in plastic case

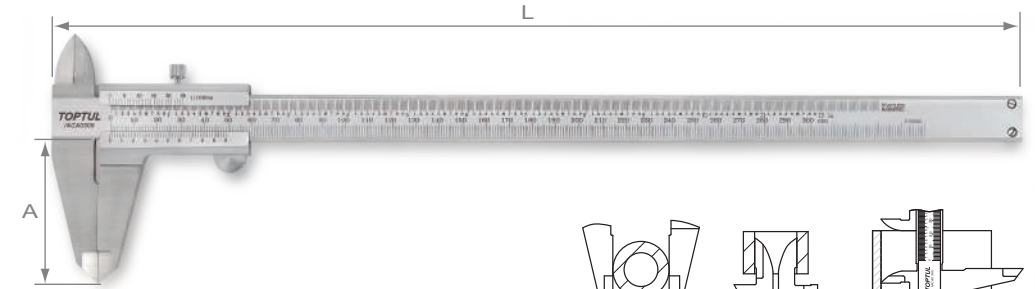

ITEM NO.	Measuring Range (mm)	A (mm)	L (mm)	📦	📦	Outside Measurement	Inside Measurement	Step Measurement	Depth Measurement
IACA0300	0 - 300	60.5	418	1	20	📏	📏	📏	📏

▶ Digital Vernier Caliper

- Caliper made of hardened and tempered Stainless Steel
- Unit of measure in mm or inch, switchable at anytime with one button
- Easy to read large LCD display (digital height 10mm)
- The zero button can reset the value to zero at any position for differential measurement
- Auto-on and 5 minutes auto-off, extending battery life

- For inside, outside, step and depth measurements
- Lock screw for sliding jaw
- Supplied in plastic case and 2 pcs LR44 batteries
- Operating Temperature: 0~40°C (32~104°F)
- Storage Temperature: -20~70°C (-4~158°F)

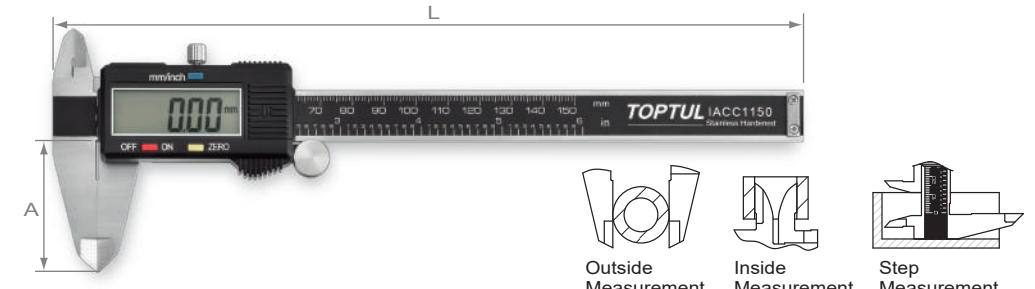

ITEM NO.	Measuring Range (mm)	A (mm)	L (mm)	Resolution (mm)	Accuracy (mm)	📦	📦
IACC1150	0 - 150	40	235	0.01 (0.0005")	≤100mm: 0.02 (0.001") >100mm: 0.03 (0.001")	10	50

▶ T-Handle Ratchet Wrench

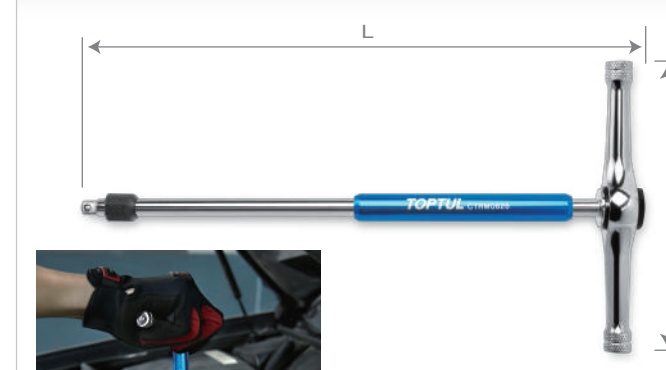

- Made of Chrome Vanadium Steel material
- T-handle design with reversible 72 teeth fine gear ratchet mechanism, return angle of 5 degrees
- Quick-release mechanism ensures firm socket retention and easy socket removal
- Special aluminum sleeve grip allows the shank to spin freely for quick tightening or loosening of the fastener
- Ideal for automotive fastening applications
- In accordance to DIN 3120, ISO 1174-1

- 72 teeth ratcheting action only requires a 5-degree swing arc to operate, perfect for close quarters work in tight spots

- Quick-release mechanism ensures firm socket retention and easy socket removal



DRIVE	ITEM NO.	L (mm)	L1 (mm)	📦	📦
1/4"	CTRM0826	260	132	10	40
3/8"	CTRM1227	270	134	10	40



A-19

**▶ Pro-Plus Series
Spinner Handle**

- Made of Chrome Vanadium Steel Material
- Ergonomically shaped, bi-component PP+TPR grip handle for maximum power transmission

ISO 3315 ASME B107.10
CR-V DIN 3122

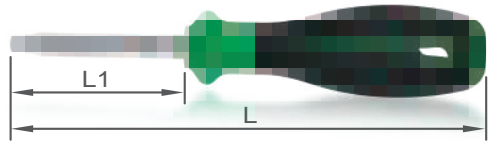

Satin Chrome Finished

DRIVE	ITEM NO.	L1 (mm)	L (mm)	Box	Weight
1/4"	CAIF0816	60	162	5	40

▶ 10PCS 1/2" DR. 6PT Socket Rail Set

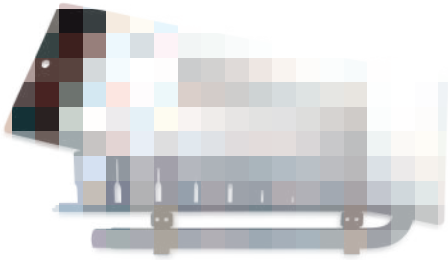

Satin Chrome Finished

ITEM NO.	CONTENTS	Box	Weight
GAAG1010	9 BAEA1610-1624 10, 11, 13, 14, 17, 19, 21, 22, 24 mm 1 AFAN1610 1/2" Dr. L-Handle (90° Offset) - 10" (L)	8 (SET)	

▶ 9PCS 1/2" DR. Star Socket Set

1/2"



Satin Chrome Finished

ITEM NO.	CONTENTS	Box	Weight
GAAD0907	9 BAED1610-1624 1/2" Dr. Star Sockets E10, E11, E12, E14, E16, E18, E20, E22, E24	10 (SET)	

METAL CASE: W197 x D103 x H33 (mm)

▶ 18PCS Angled Socket Wrench Set



Satin Chrome Finished

ITEM NO.	CONTENTS	Box	Weight
GVD1811	18 AEAE0707-3232 Angled Socket Wrenches 7, 8, 10, 11, 12, 13, 14, 15, 16, 17, 18, 19, 21, 22, 24, 27, 30, 32 mm	2 (SET)	

MEMO



IMPACT SOCKETS & PNEUMATIC TOOLS

▶ **6PT Flank Impact Sockets**

CR-MO DIN 3121



METRIC

Black Phosphate Finished

DRIVE	ITEM NO.	SIZE(mm)	L(mm)		
2-1/2" 63mm sq.	KABA8075	75	140	1	2
	KABA8080	80	140	1	2
	KABA8085	85	140	1	2
	KABA8090	90	145	1	2
	KABA8095	95	145	1	2
	KABA80A0	100	150	1	2
	KABA80A5	105	155	1	2
	KABA80B0	110	160	1	2
	KABA80B5	115	165	1	2
	KABA80C0	120	170	1	1

▶ **Impact Adapter**

CR-MO DIN 3121

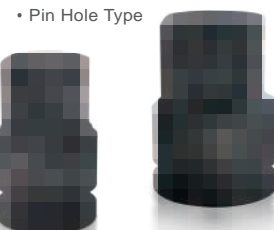

Black Phosphate Finished

DRIVE	ITEM NO.	SIZE	L (mm)		
1" (25mm)	KACP3248	1"(F) x 1-1/2"(M)	90	2	16
1-1/2" (40mm)	KACP4880	1-1/2"(F) x 2-1/2"(M)	120	2	4

TOPTUL

▶ **20PCS 1/2" DR. Air Impact Wrench Set**

- Heavy duty 1/2 S.Q. twin hammer mechanism air impact wrench, front exhaust (Adjustable power regulator, 5-position forward and reverse power setting)
- Include one mini oiler to keep impact wrench lubricated

1/2" • Storage room for bolts, nuts and small spare parts



ITEM NO. GDAI2002E

CONTENTS 3 (SET)

- 1 KAAA1660B
1/2" Dr. Standard Anvil Super Duty Air Impact Wrench (600 ft-lb / 813 Nm)
- 12 KABA1610-1627
1/2" Dr. 6PT Flank Impact Sockets
10, 11, 12, 13, 14, 16, 17, 19, 21, 22, 24, 27 mm
- 3 KABE1617-1621
1/2" Dr. 6PT Flank Deep Impact Sockets - 17, 19, 21 mm
- 1 KACE1605
1/2" Dr. Impact Extension Bar - 5" (L)
- 1 KALB1501
Oil Pot - 15 c.c
- 1 KALA0815
1/4" Mini Oiler
- 1 KALC081E (Item No. GDAI2002E)
1/4" Air Inlet Nipple (European Type)
- 1 KALC082J (Item No. GDAI2002J)
1/4" Air Inlet Nipple (Japanese Type)

BLOW CASE: W478 x D234 x H100 (mm)

▶ **1/4" DR. / 3/8" DR. / 1/4" HEX. Mini Multi-Function Air Ratchet Wrench Set**

- Super durable compact ratchet head with 3 pcs adapters, 1/4", 3/8" square drive & 1/4" Hex. bit holder
- Double-sided use, change the position of the adapter to switch between forward and reverse
- Rear Exhaust



• **Powerful & Lightweight Model**

ITEM NO. GDAE0402

SPECIFICATIONS 20 (SET)

Max. Torque	40 ft-lb / 54 Nm
Free Speed	400 RPM
Air Pressure	90 PSI / 6.2 BAR
Air Consumption	3 CFM
Air Inlet	1/4" PT
Min. Air Hose	3/8" I.D.
Overall Length	6-5/16" / 160 mm
Net Weight	1.06 lbs / 0.48 kgs

TOPTUL®

Reversible Air Drill Series

- Well Balanced Multi Purpose Heavy Duty Air Drill
- Perfect for Automotive & Industrial Applications

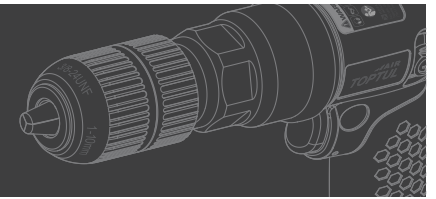

▶ **Reversible Air Drill, 10 mm (3/8") Keyless Chuck**

- Ideal for drilling, honing, reaming and hole sawing
- Side forward/reverse switch allowing one hand operation for easy usage
- Progressive trigger mechanism for better control of drilling speed
- 360° swivel air inlet prevents the air hose from damage
- Quick-change keyless chuck for fast and easy changing of drill bits
- Anti-slip contoured elastomer comfortable grip handle

ITEM NO. KAQA1220

SPECIFICATIONS 10

Chuck Size	10 mm (3/8")
Power	0.5 HP / 0.37 KW
Free Speed	2000 RPM
Air Pressure	90 PSI / 6.2 BAR
Air Consumption	4 CFM / 113 l/min
Air Inlet	1/4" PT
Air Hose	3/8" I.D.
Overall Length	210 mm / 8-1/4"
Net Weight	1.8 lbs / 0.8 kgs
Sound Pressure Level	91 dB(A)
Vibration Level	0.2 M/Sec ²



▶ **Reversible Air Drill, 13 mm (1/2") Keyless Chuck**

- Ideal for drilling, honing, reaming and hole sawing
- Side forward/reverse switch allowing one hand operation for easy usage
- Progressive trigger mechanism for better control of drilling speed
- 360° swivel air inlet prevents the air hose from damage
- Quick-change keyless chuck for fast and easy changing of drill bits
- Anti-slip contoured elastomer comfortable grip handle
- Ergonomic, auxiliary side handle for increased control

ITEM NO. KAQA1650

SPECIFICATIONS 10

Chuck Size	13 mm (1/2")
Power	0.5 HP / 0.37 KW
Free Speed	500 RPM
Air Pressure	90 PSI / 6.2 BAR
Air Consumption	4 CFM / 113 l/min
Air Inlet	1/4" PT
Air Hose	3/8" I.D.
Overall Length	265 mm / 10-1/2"
Net Weight	2.7 lbs / 1.2 kgs
Sound Pressure Level	92 dB(A)
Vibration Level	0.2 M/Sec ²



TOPTUL®

Super Duty Air Impact Wrench

- Impact Mechanism : Twin Hammer
- Handle Exhaust with Muffler

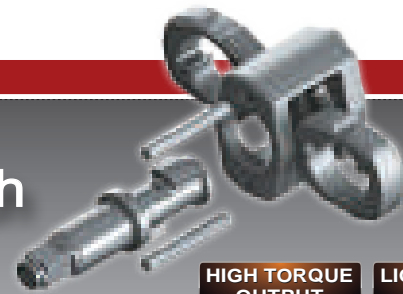

HIGH TORQUE OUTPUT **LIGHTWEIGHT MODEL**

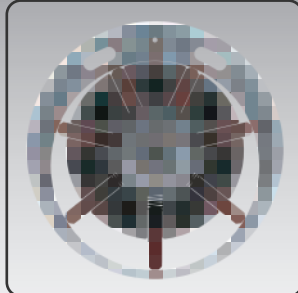

• Unique blade auxiliary spring and spring holder design help improve maximum torque output by 25%. High performance impact mechanism can even be started in a low pressure environment

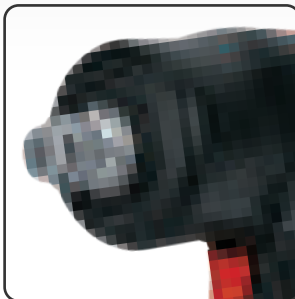

• Features an adjustable 3-position forward and one full power reverse setting

▶ 1/2" DR. Super Duty Air Impact Wrench



950 FT-LBS

• High Torque Output & Lightweight Model

ITEM NO.	KSAC1680	📦 10
SPECIFICATIONS		
Max. Torque	950 ft-lb / 1288 Nm	
Working Torque	800 ft-lb / 1085 Nm	
Free Speed	8500 RPM	
Air Pressure	90 PSI / 6.2 BAR	
Air Consumption	5.5 CFM	
Air Inlet	1/4" PT	
Min. Air Hose	3/8" I.D.	
Overall Length	7-3/32" / 180 mm	
Net Weight	3.64 lbs / 1.65 kgs	

▶ 3/4" DR. Super Duty Air Impact Wrench



950 FT-LBS

• High Torque Output & Lightweight Model

ITEM NO.	KSAC2480	📦 10
SPECIFICATIONS		
Max. Torque	950 ft-lb / 1288 Nm	
Working Torque	800 ft-lb / 1085 Nm	
Free Speed	8500 RPM	
Air Pressure	90 PSI / 6.2 BAR	
Air Consumption	5.5 CFM	
Air Inlet	1/4" PT	
Min. Air Hose	3/8" I.D.	
Overall Length	7-33/64" / 191 mm	
Net Weight	4.08 lbs / 1.85 kgs	

▶ 3/4" DR. Super Duty Air Impact Wrench



1550 FT-LBS

• High Torque Output & Lightweight Model

ITEM NO.	KSAC2413	📦 6
SPECIFICATIONS		
Max. Torque	1550 ft-lb / 2102 Nm	
Working Torque	1250 ft-lb / 1695 Nm	
Free Speed	6000 RPM	
Air Pressure	90 PSI / 6.2 BAR	
Air Consumption	7.0 CFM	
Air Inlet	3/8" PT	
Min. Air Hose	3/8" I.D.	
Overall Length	8-1/2" / 216 mm	
Net Weight	6.61 lbs / 3.0 kgs	

▶ 1" DR. Super Duty Air Impact Wrench



1550 FT-LBS

• High Torque Output & Lightweight Model

ITEM NO.	KSAC3213	📦 6
SPECIFICATIONS		
Max. Torque	1550 ft-lb / 2102 Nm	
Working Torque	1250 ft-lb / 1695 Nm	
Free Speed	6000 RPM	
Air Pressure	90 PSI / 6.2 BAR	
Air Consumption	7.0 CFM	
Air Inlet	3/8" PT	
Min. Air Hose	3/8" I.D.	
Overall Length	8-13/16" / 224 mm	
Net Weight	6.94 lbs / 3.15 kgs	

▶ 1" DR. Super Duty Air Impact Wrench



2200 FT-LBS

• High Torque Output & Lightweight Model

ITEM NO.	KSAC3220	📦 4
SPECIFICATIONS		
Max. Torque	2200 ft-lb / 2983 Nm	
Working Torque	2000 ft-lb / 2712 Nm	
Free Speed	5500 RPM	
Air Pressure	90 PSI / 6.2 BAR	
Air Consumption	7.5 CFM	
Air Inlet	1/2" PT	
Min. Air Hose	1/2" I.D.	
Overall Length	10-3/64" / 255 mm	
Net Weight	12.57 lbs / 5.7 kgs	

▶ 1" DR. Long Anvil Super Duty Air Impact Wrench

- Impact Mechanism : Twin Hammer
- Side Exhaust
- Inside Trigger

One of the lightest, most powerful super duty 1" square drive extended anvil impact wrenches. Features an adjustable 3-position forward and one full power reverse setting. Auxiliary side handle for ease of control. Twin hammer mechanism promotes an even maximum force on lug nut or bolt. Applicable in the general industrial use, construction, heavy duty truck tire service works.



2200 FT-LBS

• Powerful & Lightweight Model

ITEM NO.	KSAD3220	📦 2
SPECIFICATIONS		
Max. Torque	2200 ft-lb / 2983 Nm	
Working Torque	2000 ft-lb / 2712 Nm	
Free Speed	5500 RPM	
Air Pressure	90 PSI / 6.2 BAR	
Air Consumption	7.5 CFM	
Air Inlet	1/2" PT	
Min. Air Hose	1/2" I.D.	
Overall Length	22-51/64" / 579 mm	
Net Weight	15.87 lbs / 7.2 kgs	

LIGHT MODEL

▶ **3/4" DR. Super Duty Air Impact Wrench**

- Impact Mechanism : Twin Hammer
- Patent grease injection hole design for easy to lubricate the impact mechanism
- Includes a grease tube (ITEM NO.: KALJ0201) that can be used four times
- Handle Exhaust



1200 FT-LBS

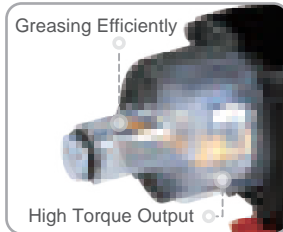
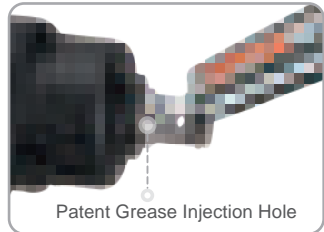

• **Powerful & Lightweight Model**

ITEM NO.	KAAA2412
SPECIFICATIONS	
Max. Torque	1200 ft-lb / 1627 Nm
Free Speed	7200 RPM
Air Pressure	90 PSI / 6.2 BAR
Air Consumption	8.13 CFM
Air Inlet	1/4" PT
Min. Air Hose	3/8" I.D.
Overall Length	6-31/32" / 177 mm
Net Weight	5.82 lbs / 2.64 kgs

▶ **Heavy Duty Air Angle Grinder**



- Multifunctional angle grinder suitable for cutting, grinding, polishing, paint removal, rust removal and etc.
- Adjustable protective steel wheel guard
- Safety lock throttle lever to prevent accidental start-up
- Ergonomic side handle for ease of use and comfort
- Front exhaust

ITEM NO.	KAKC0595
SPECIFICATIONS	
Grinding Wheel Dia. x Arbor Hole	5" x 7/8" (125 x 22 mm)
Power	0.8 HP / 0.59 KW
Free Speed	9500 RPM
Air Pressure	90 PSI / 6.2 BAR
Air Consumption	6 CFM / 169 l/min
Air Inlet	1/4" PT
Air Hose	3/8" I.D.
Overall Length	8-3/4" / 222 mm
Net Weight	4.18 lbs / 1.9 kgs
Sound Pressure Level	82 dB(A)
Vibration Level	6.5 M/Sec ²

▶ **2.5" Mini Air Angle Grinder**

- Multi-functional angle grinder suitable for cutting, grinding, polishing, paint removal, rust removal and etc.
- Lightweight and powerful, high-speed rotation, quick cutting or grinding
- Adjustable protective steel wheel guard
- Safety lock throttle lever to prevent accidental start-up
- Rear Exhaust

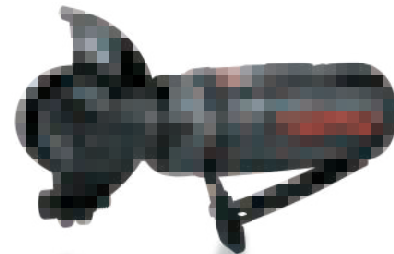

• Grinding wheel not included

• **Powerful & Lightweight Model**

ITEM NO.	KASC0318
SPECIFICATIONS	
Grinding Wheel Dia. x Arbor Hole	2-1/2" x 3/8" (60 x 9.5 mm)
Power	0.3 HP / 0.224 KW
Free Speed	18000 RPM
Air Pressure	90 PSI / 6.2 BAR
Air Consumption	3 CFM / 84 l/min
Air Inlet	1/4" PT
Air Hose	3/8" I.D.
Overall Length	5-1/8" / 130 mm
Net Weight	1.17 lbs / 0.53 kgs
Sound Pressure Level	81.5 dB(A)
Vibration Level	2.5 M/Sec ²

▶ **Mini Air Straight Die Grinder**

- Includes two collet chucks: 6 mm (pre-inserted) & 1/4"
- Mini design for working in confined areas
- Safety lock throttle lever to prevent accidental start-up
- Suited for grinding, polishing, burnishing and deburring applications
- Rear Exhaust

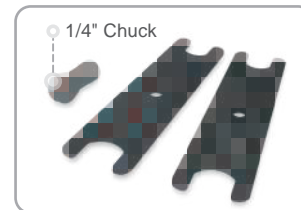

• **Powerful & Lightweight Model**

ITEM NO.	KASA0825
SPECIFICATIONS	
Collet Chuck	6 mm & 1/4"
Power	0.3 HP / 0.224 KW
Free Speed	25000 RPM
Air Pressure	90 PSI / 6.2 BAR
Air Consumption	3 CFM / 84 l/min
Air Inlet	1/4" PT
Air Hose	3/8" I.D.
Overall Length	4-17/32" / 115 mm
Net Weight	0.64 lbs / 0.29 kgs

▶ **Mini Air Angle Die Grinder**

- Includes two collet chucks: 6 mm (pre-inserted) & 1/4"
- Specific mini and 90° angled design for reaching confined spaces easier
- Safety lock throttle lever to prevent accidental start-up
- Suited for grinding, polishing, burnishing and deburring applications
- Rear Exhaust

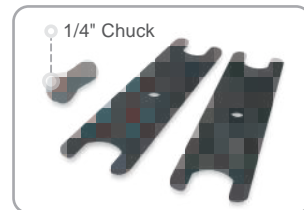
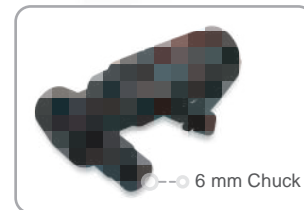

• **Powerful & Lightweight Model**

ITEM NO.	KASD0818
SPECIFICATIONS	
Collet Chuck	6 mm & 1/4"
Power	0.3 HP / 0.224 KW
Free Speed	18000 RPM
Air Pressure	90 PSI / 6.2 BAR
Air Consumption	3 CFM / 84 l/min
Air Inlet	1/4" PT
Air Hose	3/8" I.D.
Overall Length	4-15/16" / 125 mm
Net Weight	0.95 lbs / 0.43 kgs

▶ **Air Hose Reel**

- Robust metal case for heavy-duty applications
- Polyurethane Braid Hose can be extended and retracted by simple pull and release mechanism
- Automatic rewind hose reel with SK5 spring steel spring provides easy locking and retracting of hose
- Built-in 16 teeth multi-position ratchet gear lock system for securing hose at desired length and ensures maximum safety and reliability
- Movable retaining ball allows easy adjustment of leader hose to desired length
- Quickly and easily replaceable air hose design
- Supplied with swivel metal mounting bracket for fixing to wall or ceiling
- Max. Working Pressure: 300 PSI
- Working Temperature: -10°C to 65°C



• Disassemble & replace the connection air hose

ITEM NO.	Hose I.D. (mm)	Hose O.D. (mm)	Hose Length (M)	Coupler Type	Air Inlet / Outlet	1	2
KHAP0810E	8	12	10	EU	1/4" PT	1	2
KHAP0815E	8	12	15	EU	1/4" PT	1	2
KHAP1010E	9.5	13.5	10	EU	1/4" PT	1	2
KHAP1012E	9.5	13.5	12	EU	1/4" PT	1	2
KHAP1015E	9.5	13.5	15	EU	1/4" PT	1	2
KHAP1020E	9.5	13.5	20	EU	1/4" PT	1	2

HVLP Gravity Feed Spray Gun

- Highly efficient HVLP design complies with environmental regulation requiring high volume, low pressure, saving materials and very lower over-spray
- Professional gravity feed spray gun with 1.4 mm set-up, ideal for applying top coats
- Air and paint flow control device for fine adjustment of spray flow
- Round/flat fan control allows spray pattern to be adjusted for any job
- Brass air cap with stainless steel needle and nozzle suitable for most coatings

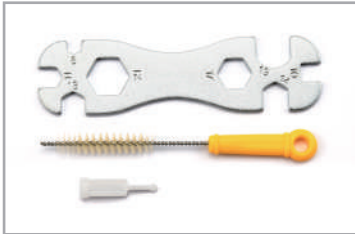

Contents:
1PC HVLP Gravity Feed Spray Gun
1PC Nylon Gravity Cup
1PC Multifunctional Wrench
1PC Cleaning Brush
1PC Paint Filter

ITEM NO.	KANA14N6	10
SPECIFICATIONS		
Feed Type	Gravity	
Cup Capacity	600 ml	
Standard Nozzle	1.4 mm	
Optional Nozzle	1.0, 1.2, 1.3, 1.4, 1.5, 1.6, 1.8, 2.0, 2.5 mm	
Fluid Output	150 ml/min	
Pattern Width	310 mm	
Working Pressure	15 - 28 PSI / 1.03 - 1.93 BAR	
Air Consumption	12 CFM	
Air Inlet	1/4" PF	
Gun Weight	1.13 lbs / 514 g	



Nylon Gravity Cup

- Capacity: 600 ml
- Material: Nylon
- Use with TOPTUL KANA14N6 (HVLP Gravity Feed Spray Gun)



ITEM NO.	Capacity	Fluid Inlet	20
KALN0160	600 ml	M16 x 1.5P	

SPRAY GUN CLEAN



17PCS Spray Gun Cleaning Set



ITEM NO. GDAR1701 **12 (SET)** **72 (SET)**

- Various sized brushes and needles can be used with all types of paint thinners and spray gun cleaning solvents
- Ideal for cleaning all types of suction tube, gravity feed, detail, touch up and pressure spray guns
- Set includes:
12 mm Pick Up Tube Brush (L=305 mm)
12 mm Body Cavity Brush (L=235 mm)
10 mm Body Cavity Brush (L=155 mm)
8 mm HVLP Brush (L=160 mm)
Single-End Detail Brush
Nylon Bristle Brush
5PCS Miniature Brushes (Ø 2, 2.5, 3, 4, 5 mm)
6PCS Precision Needles (Ø 0.5, 0.8, 1.0, 1.2, 1.4, 1.6 mm)

Air Windshield Cutter W/Hose

- Quickly and easily cuts windscreens and other glued parts
- Safety lock lever to prevent accidental start-up
- Integral regulator for speed control
- Flexible blade mount can be positioned in 12 different ways
- For one handed operation with ergonomic design
- Rear exhaust drives air away from the workplace
- Includes one straight offset blade (ITEM NO. KAJC54A1) and a 3/16" allen wrench



ITEM NO.	KBHA0120	10
SPECIFICATIONS		
Oscillations / Minute	20,000	
Stroke Arc	2°	
Overall Length	7-11/16" / 195 mm	
Net Weight	2.14 lbs / 0.97 kgs	
Air Inlet	1/4" PT	
Min. Air Hose	3/8" I.D.	
Air Pressure	90 PSI / 6.2 BAR	
Average Air Consumption	4.0 CFM / 113 l/min	
Sound Pressure Level	80 dB(A)	
Sound Power Level	91 dB(A)	
Vibration Level	14 M/Sec ²	

BLADE SERIES

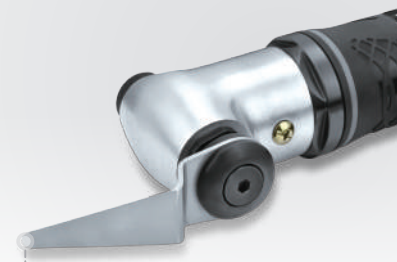

Provides a variety of optional blades to improve the application of the tool in the workshop

Scraper Blade

- Made of polished Stainless Steel



ITEM NO.	L(mm)	30	120
KAJC45C1	45		

Straight Offset Blade

- Made of polished Stainless Steel



ITEM NO.	L(mm)	20	80
KAJC54A1	53.5		

Hooked Blade

- Made of polished Stainless Steel



ITEM NO.	L(mm)	20	80
KAJC21B1	20.5		

Hooked Blade

- Made of polished Stainless Steel



ITEM NO.	L(mm)	20	80
KAJC38B1	38		

Hooked Blade

- Made of polished Stainless Steel



ITEM NO.	L(mm)	20	80
KAJC62B2	61.5		

B-09

▶ 1/4" Hex Shank 3-Jaw Keyless Drill Chuck

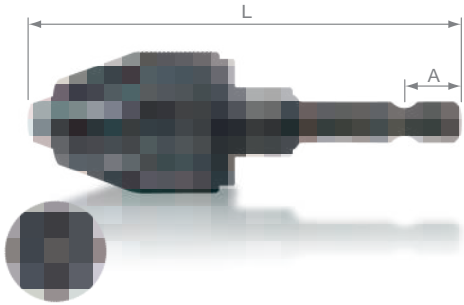

- Durable all metal construction chuck
- Extra hardened jaws with high clamping force
- Three-jaw chuck design to securely hold drill bits of both round and hex shanks
- Keyless chuck allows quick lock onto and release of drill bits
- Easily convert power screwdriver into a drill or grinder
- Drill bit holding capacity: 0.5mm - 6.35mm diameter

DRIVE	ITEM NO.	A (mm)	DRILL HOLDING CAPACITY Ø (mm)	L (mm)		
1/4"	FTHA0806	9.5	0.5 - 6.35	75	25	100
	FTHB0806	13.5	0.5 - 6.35	75	25	100

3-Jaw Chuck
Universal chuck grips both round or hex shank drill bits

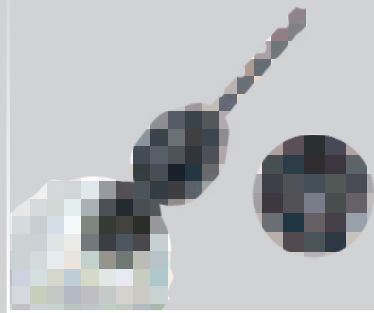

1/4 Inch Hex Shank
Ideal for use with cordless screwdrivers fitted with a quick chuck

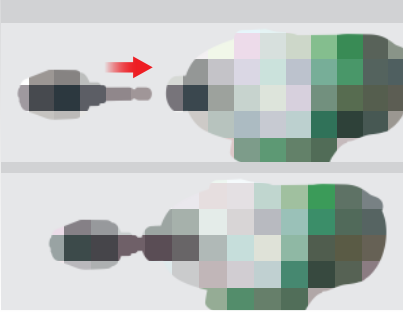

Dismountable Shank
Keyless design to lock and release the drill bit easily. Quick release and change for high efficiency

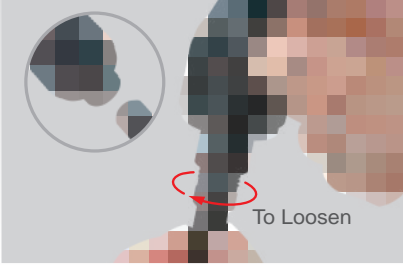

▶ Quick Change Impact Adapter

- Made of tempered and hardened Chrome Vanadium Alloy Steel
- Heavy duty construction design provides maximum strength and durability
- Quick-release chuck with knurled sleeve for fast and easy bit changes
- Hexagonal adapter securely holds any type of 1/4" hex shank bit
- Ideal for converting an air or power impact wrench into a screwdriver or drill

CR-V ASME B107.4



Quick change mechanism allows easy removal of the hex shank power bits

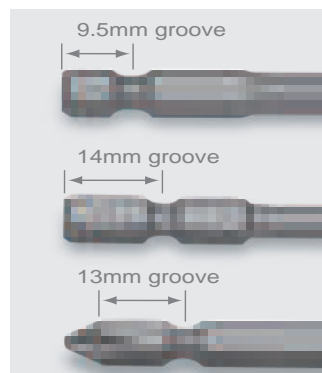

Fits most common 1/4" hex shank power bits

ITEM NO.	DRIVE (inch)	Hex Shank	Black Phosphate Finished		
			L (mm)		
KADD1208	3/8	1/4"	40	50	100
KADD1608	1/2	1/4"	45	50	100

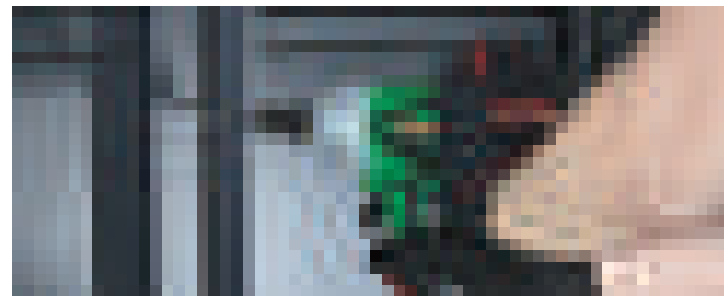

AUTO TOOLS



▶ Exhaust Clamp Pliers

- Designed to remove and install exhaust clamps
- Ratchet locking and quick release mechanism can hold the exhaust clamp for easier and faster working
- Large points-guide sleeve prevents slippage
- Suitable for Citroën, Peugeot, Renault and other open types of exhaust clamps

CR-MO

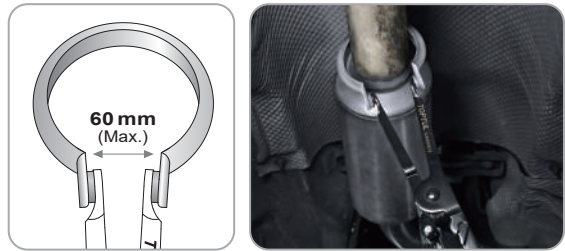

ITEM NO.	Length (mm)	Max. Jaw Opening (mm)	📦	📦
JDAM0512	300 (12")	60	12	36

▶ Brake Disc & Tire Depth Gauge

- Suitable for measuring the thickness of brake disc and tire depth
- Clamping screw to easily retain reading
- Special jaw release mechanism allows reading of the brake disc to be retained without releasing the clamping screw
- Compact size allows for access in tight spaces
- Metric scale with 0.1mm graduations
- Made of Aluminum
- Measure range: 0-60mm

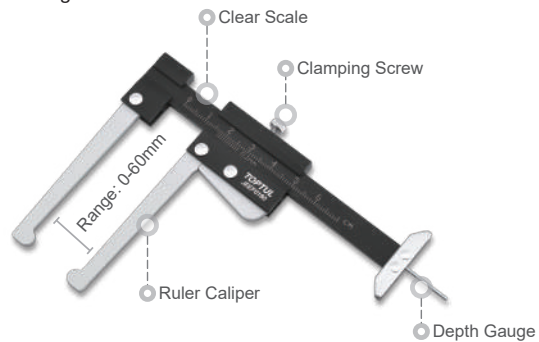

ITEM NO.	Range (mm)	📦	📦
JEEF0160	0 - 60	24	240

▶ Exhaust Hanger Removal Pliers

- Specially designed tool for the removal of exhaust system rubber type hangers (i.e. tailpipe, exhaust pipe, and muffler)
- 25 degree offset allows for easy access to confined areas
- Self-locating forcing pin designed to quick remove of rubber exhaust hangers
- Suitable for a wide range of cars and light commercial vehicles
- Jaws opening range 5 to 55mm
- Made of Chrome Molybdenum Alloy Steel

CR-MO



ITEM NO.	LENGTH (mm)	📦	📦
JEAR2906	285 (11")	12	36

▶ Digital Tire Tread Depth Gauge

- Suitable for measuring the tire tread depth
- Easy to read LCD display (digital height 7.5mm)
- Auto-on and 5 minutes auto-off, extending battery life
- Unit of measure in mm or inch, can be converted at any time with one button
- Lightweight and durable
- Operating Temperature: 0 - 40°C (32 - 104°F)
- Power Supply: LR44 or SR44 Battery x 1 pc (included)



• Depth Measuring Probe



ITEM NO.	Measuring Range (mm)	Resolution (mm)	📦	📦
JEBM0125	0 - 25.4 (0 - 1")	0.01 (0.0005")	25	100

▶ Handbrake Cable Spring Pliers

- Suitable for disassembly and assembly of the handbrake cable on the brake shoes of drum brakes
- For compression of the retaining spring on the handbrake cable
- Spring loaded pliers handles for ease of use
- Made of heat treated, durable Chrome Molybdenum Steel
- Application: VW, Audi, BMW, Citroën, Nissan, Peugeot, Renault, Rover, Seat and etc.

CR-MO

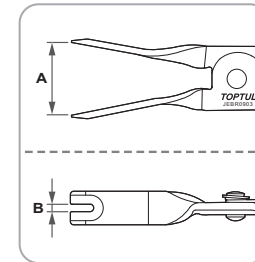

ITEM NO.	Length (mm)	Max. Jaw Opening A (mm)	Gap Width B (mm)	📦	📦
JEBR0903	230 (9")	34	3.5	12	72

▶ Universal Bearing Ring Puller

- Designed for quick and easy removal of the wheel bearing inner race from the hub
- Three jaws and conical center screw ensure even distribution of tension to avoid any slide or tilt
- Features a locking mechanism to locate and hold the jaws in the correct position
- Ultra sharp jaw edges allow to clamp in between 1.0mm gap
- Suitable for most vehicle hubs
- Jaws Capacity: Ø40-130mm



No impact / power drive.



ITEM NO.	CAPACITY Ø (mm)	📦
JECD0112	40 - 130	6

▶ Portable Bearing Packer

- Handy tool for quickly packing bearings with less mess
- Simply press down the cap to flush old grease out and packs bearing with new grease
- Works on bearing up to 90mm (3-1/2") O.D.
- Transparent, impact resistant cup allows grease level check
- Suitable for most tapered roller bearings fitted on cars, boats, trailers and etc.



ITEM NO.	Max. Capacity Ø (mm)	📦
JJBH0110	90 (3-1/2")	36

▶ **Oil Drain Plug Wrench for VAG**

- Specially designed tool for removing and installing the plastic oil drain plug without damage
- Features T-handle for quick operation
- Suitable for VAG 1.8, 2.0 TSI / TFSI; 1.6, 2.0 TDI and Porsche Type 991 / Type 95B engines
- Application:
VW - Beetle, Caddy, CC, Golf, Jetta, Passat, Polo, Scirocco, Sharan, Tiguan, Touran
Audi - A1, A3, A4, A5, A6, A7, Q3, Q5, Q7, TT, TTS
Skoda - Octavia, Rapid, Superb, Yeti
Seat - Alhambra, Ibiza, Leon, Toledo
Porsche - 911 Carrera, Carrera S, Carrera 4, Carrera 4S, Targa 4, Targa 4S 3.0L (2017-) and Macan 2.0L (2017-)

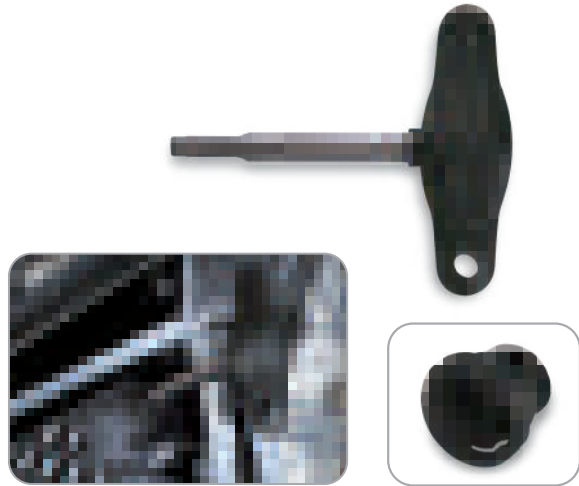

ITEM NO.	L (mm)	Handle Width (mm)	📦	📦
JDCR0109	90	80	12	72

▶ **3/8" DR. Oil Drain Plug Bit Socket for VAG**

- Specially designed tool for removing and installing the plastic oil drain plug without damage
- 3/8" square drive with 17mm hex shank
- Suitable for VAG 1.8, 2.0 TSI / TFSI; 1.6, 2.0 TDI and Porsche Type 991 / Type 95B engines
- Application:
VW - Beetle, Caddy, CC, Golf, Jetta, Passat, Polo, Scirocco, Sharan, Tiguan, Touran
Audi - A1, A3, A4, A5, A6, A7, Q3, Q5, Q7, TT, TTS
Skoda - Octavia, Rapid, Superb, Yeti
Seat - Alhambra, Ibiza, Leon, Toledo
Porsche - 911 Carrera, Carrera S, Carrera 4, Carrera 4S, Targa 4, Targa 4S 3.0L (2017-) and Macan 2.0L (2017-)



ITEM NO.	DRIVE	● (mm)	L (mm)	📦	📦
JDCR0203	3/8"	17	33.5	12	144

▶ **12PCS Air Valve Lapper Tool Kit**

• Rotate left and right

ITEM NO.	JGAI1205	📦 5 (SET)
----------	----------	-----------

Features:

- Pneumatic design for faster, more accurate and easier valve grinding
- Through automatic left and right rotation, the grinding surface is more uniform
- Lightweight (only 0.6kg), practical and easy to use with one hand
- Includes 5 sizes of suction cups 16, 20, 30, 35, 45 mm, 5pcs shafts and a 3mm hex allen key

Specifications:

- Blow Per Minute: 800 BPM
- Air Pressure: 90 PSI / 6.2 BAR
- Air Consumption: 2.12 CFM
- Air Inlet: 1/4" PT
- Min. Air Hose: 1/4"

BLOW CASE: W320 x D230 x H90 (mm)

▶ **6PCS 3/4" DR. Deep Impact Socket Set - Star & 12PT**

- Made of impact quality Chrome Molybdenum Alloy Steel (CR-MO) DIN 3121
- Suitable for removing and installing the HGV cylinder head bolts
- Black phosphate finish for extended corrosion resistance
- Applications:
17mm (12PT) For MAN, Mercedes-Benz 400/420/500
19mm (12PT) For Mercedes-Benz 300/400/900 Actros
E18 For MAN M2000 and MAN buses with D08 engines
E20 For MAN F2000, F90, F8 and MAN buses with D25/D28 engines
E22 For MAN TGA engines
E24 For MAN D20 engines

ITEM NO.	CONTENTS	📦 6 (SET)
JGAI0602	2 KABF2417 & KABF2419 3/4" DR. 12PT Flank Deep Impact Sockets (L=110mm) 17 & 19 mm	
	4 KABS2418-2424 3/4" DR. Deep Star Impact Sockets (L=110mm) E18, E20, E22, E24	

BLOW CASE: W272 x D212 x H59 (mm)

▶ **450PCS Injector Copper Sealing Ring Kit**

- For sealing injector ports on common rail diesel injection systems (CDI)
- Suitable for most of popular nozzles of injector system
- Use to install in the diesel injector after removing the old damaged washers or when changing new injectors
- Kit contains 450pcs copper seals/washers, 30pcs for each size

ITEM NO.	CONTENTS	📦 12 (SET)
JGEW450A	Sealing Ring Sizes: Outside Diameter x Inside Diameter x Thickness (mm) Ø13.85xØ7.3x1.4, Ø14.6xØ7.5x1.3, Ø14.6xØ7.5x3, Ø15xØ7x2, Ø15xØ7.5x1, Ø15xØ7.5x1.5, Ø15xØ7.5x2, Ø15xØ7.5x2.5, Ø15xØ7.5x3, Ø15.5xØ7.5x2, Ø16xØ7.5x1.5, Ø16xØ7.5x1.7, Ø16xØ7.5x2, Ø16.4xØ7.4x2, Ø20xØ9.4x0.9	

PLASTIC BOX: W205 x D145 x H39 (mm)

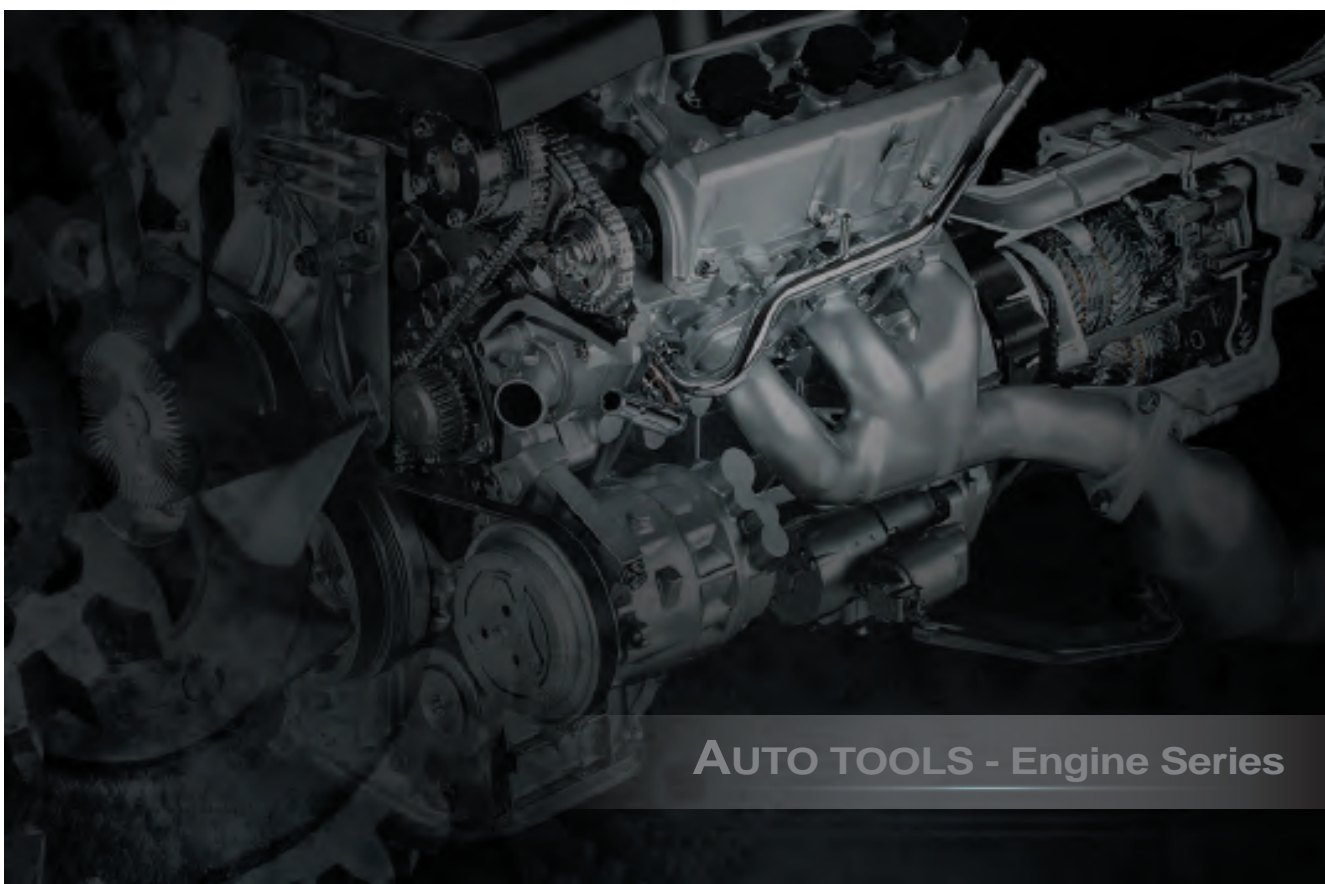

▶ Windshield Removal Tool

- Specially designed tool to easily and safely remove bonded windshields and backlights
- Tempered steel blade precisely cuts the adhesive sealant around windshields
- Fully replaceable blade
- Large durable aluminum handle, combined with a steel cable pull handle provides extra grip and leverage
- Supplied with 1" (25mm) tempered steel blade (Replacement Blade Part No. JLBH0401)

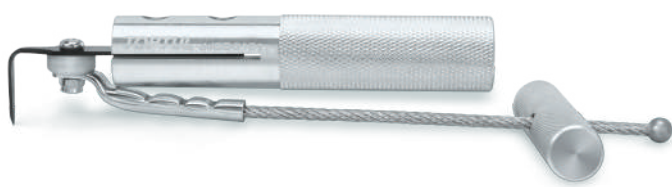

ITEM NO.	Blade Length		
JJCD0101	1" (25mm)	12	48

▶ 6PCS Windshield Removal Tool Blade Set

- 6 pcs spare blades for TOPTUL Part No. JJCD0101 Windshield Removal Tool
- Blade made of tempered spring steel
- Highly sharpened to cut faster

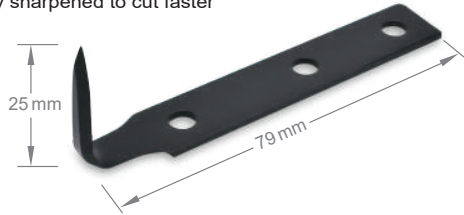

ITEM NO.	Blade Length		
JLBH0401	1" (25mm)	12	144

▶ 2PCS Bodywork File Holder Set

- Lightweight and durable aluminum alloy die-cast handle
- Adjustable bodywork file holder to match the surface of flat and curved workpieces
- The bending radius of the file can be steplessly controlled via the tensioning system
- Double-sided blade radially milled
- Ergonomic grips fit securely in the hand to ensure a strong and sturdy grip
- Ideal for any surface work on sheet metal, non-ferrous metals and plastics
- Includes one 9TPI Bodywork File Blade (medium, radially milled)

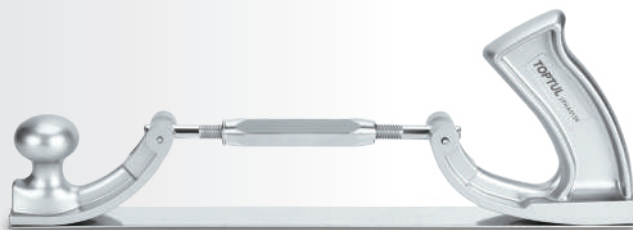

▶ Bodywork File Blade

- Suitable for Bodywork File Holder #JGAE0205
- Blade Dimension: (W)35x(T)4.5mm



ITEM NO.	CONTENTS	
JGAE0205	1 JFHA0136 Bodywork File Holder (L=350mm)	
	1 JLAT0109 9TPI Bodywork File Blade (L=355mm)	

ITEM NO.	Teeth Per Inch	Tooth Shape	Length (mm)		
JLAT0109	9	Medium, radially milled	355 (14")	10	60
JLAT0112	12	Fine, radially milled	355 (14")	10	60

▶ Hot Stapler Plastic Repair Kit

- Specialty tools for repairs and reinforcements of broken, damaged, split plastic parts
- Quick and effective repair without destroying material unnecessarily
- Kit contains three different shapes and diameters of stainless steel staple
- Suitable for repairing non-heat-resistant plastic parts, such as bumpers, spoilers, lamp holders, rearview mirrors and etc.



Specification:

- Power Rating: 100-240V / 50-60Hz, Maximum up to 20W
- Certification: CE, RoHS Approved



ITEM NO.	CONTENTS		Types of Plug Adapter (power charger)									
JGAI0102	1 Heating Device (Stapler) 1 Power Supply: AC 100-240V / 50-60Hz 100 Ø0.6 mm W Shape Staple 100 Ø0.8 mm W Shape Staple 100 Ø0.6 mm V Shape Staple	10	<table border="0"> <tr> <td></td> <td></td> <td></td> </tr> <tr> <td>A.</td> <td>E.</td> <td>U.</td> </tr> <tr> <td>(US)</td> <td>(EU)</td> <td>(UK)</td> </tr> </table>				A.	E.	U.	(US)	(EU)	(UK)
A.	E.	U.										
(US)	(EU)	(UK)										

BLOW CASE: W310 x D250 x H60(mm)

▶ Repair Staples Set

- Includes 100pcs per set
- Suitable for repairing breaks on headlamps, bumpers and etc.
- The staple are fused into the breaks
- Made of Stainless Steel

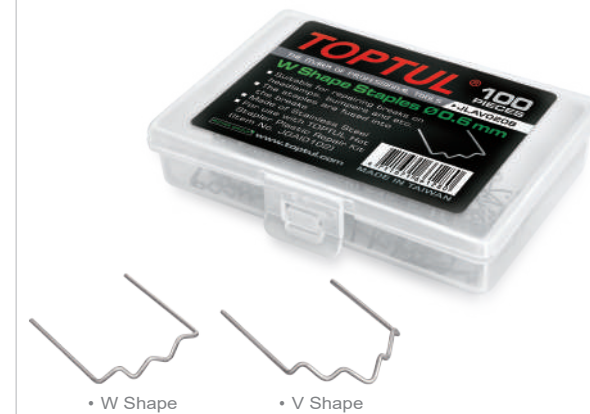

ITEM NO.	SHAPE	Ø (mm)		
JLAV0206	W	0.6	10	60
JLAV0208	W	0.8	10	60
JLAV0306	V	0.6	10	60



Expert Quality, easy to use and practical hot stapler for repairing plastic bodywork components.



The staples are pressed into the broken part to give the plastic body permanent stability.

▶ **Universal Lift Support Clamp**

- Designed to securely lock the gas/hydraulic strut rods, for safe access to engine compartment or the trunk area
- Soft metal construction of anodized aluminum with brass screw tip to prevent damage to strut shaft
- Place the support clamp on the lifting rod next to the cylinder block and tighten the knob until it is securely fixed on the lifting rod
- Maximum opening width 13mm



ITEM NO.	Max. Capacity (Opening Width)	Weight (kg)	Volume (L)
JJBG1301	13 mm	12	96

▶ **Wheel Axle Oil Drain Pan**

- Made of high density HDPE plastic, excellent resistance to impact and high temperature
- Side opening is designed for easy dumping and anti-splash
- Large and comfortable handle is easy to grasp and carry
- Suitable for collecting oil during large trucks, buses and trailers wheel repairs
- Prevents messy oil spills during wheel repair
- Meets PAHs regulations

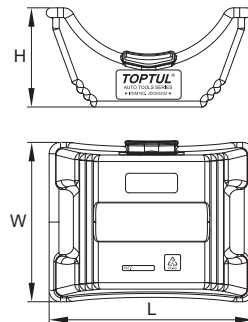

ITEM NO.	CAPACITY (Liter)	SIZE (L)x(W)x(H) mm	Weight (kg)
JDCE0203	3	315 x 245 x 155	20

▶ **Waste Oil Drain**

- Drain and collect waste oil from vehicles, ideal for working in the workshop
- Drain waste oil and sediment from engines, gearboxes and differentials of vehicles by gravity
- 80 liters steel waste oil tank with 4 swivel casters for easy movement (2 swivel casters with lock)
- 520mm large diameter metal funnel with a filter and a plastic net to prevent splashing
- Adjustable height from 1090 to 1570mm
- Clear oil level tube for easy and quick check of the oil level in the tank
- Pneumatic pressure discharging with manometer and safety valve
- Flexible drain pipe with valve, length 1700mm



- Automatic valve design, prevents discharged waste oil from backflowing

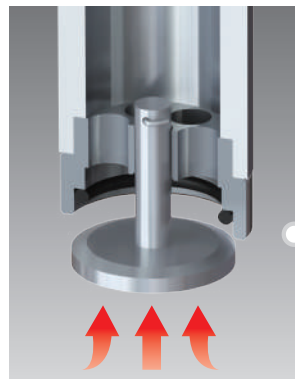

ITEM NO.	Capacity (Liter)	Dimension (L) x (W) x (H) mm	Working Pressure Kg / cm ²	Working Pressure PSI	Air Inlet	Type	Weight (kg)
JJCZ0180E	80	520 x 520 x 1090~1570	4	55	1/4" PT	EU	1
JJCZ0180J	80	520 x 520 x 1090~1570	4	55	1/4" PT	JP	1

▶ **Multi-Purpose Fluid Syringe 1.5L**

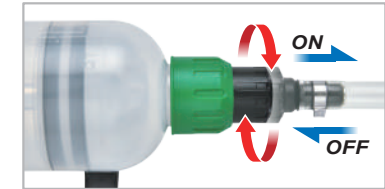

- Shut-off valve design to avoid accidental spillage

- Ideal for the transfer of oils/fluids to and from vehicle components
- Translucent body with scale allows easy inspection of the condition of the fluid
- Shut-off valve to avoid accidental spillage during fluid transfer
- Made of Polypropylene (PP) with NBR seal
- Syringe capacity 1.5 liters, hose length 400mm
- Suitable for engine oil, gear oil, differential oil, power steering fluid and etc.

ITEM NO.	Capacity (L)	Hose Length (mm)	Weight (kg)
JJZD0115	1.5	400	20

▶ **Pneumatic Fluid Extractor & Dispenser with ATF Adapter**



6 Liter

- Oil Control Gun with PU Hose (2M)
- Nylon Extraction Hose (1M)
- Universal Flexible Hose (0.7M)

Description	Application
	Mini Cooper, Audi, VW
	Ford
	Škoda, Audi, VW
	Porsche, Audi, VW
	Universal for BMW, Nissan, Honda and etc.
	Mercedes-Benz 722.9, Toyota Altis 2010
	Audi, VW CVT
	Audi, VW DSG

- Specially designed for under car transmission fluid service
- Use to extract, transfer and dispense fluid quickly, safety and cleanly
- Pneumatic operation ensures higher extraction speed and automatically dispensing
- Safety valve with pressure gauge, pre-setting of 43 PSI (3 BAR), the excess pressure will be released automatically
- Additional screw valve enables quick switch of extracting or dispensing
- All connections are simply press-on quick connects for ease of use
- Includes Oil Control Gun with 2M PU Hose, 1M Nylon Extraction Hose, 0.7M Universal Flexible Hose and 8pcs ATF Filling Adapter Kit in plastic storage case
- Application: Audi, VW DSG/CVT, Mini Cooper, Škoda, Porsche, Mercedes-Benz 722.9, Toyota Altis 2010, Ford, BMW, Nissan, Honda and etc.

ITEM NO.	EU Type Air Inlet Nipple	JP Type Air Inlet Nipple	Weight (kg)
JJEZ0106E		JJEZ0106J	6 (SET)

SPECIFICATIONS	
Working Pressure	40 - 170 PSI (2.8 - 12 BAR)
Average Air Consumption	2 CFM
Air Inlet	1/4" PT
Fluid Temperature Range	-19°C - 60°C (-3°F - 140°F)
Container Capacity	6 Liter (6000 ml)

▶ **20PCS VW Wheel Lock Nut Key Set**

- Quickly and easily removes VW locking wheel nuts without damaging wheels or the nuts
- Applicable for most VW Vehicles from 2006
- Made of Chrome Molybdenum Alloy Steel
- Chrome plated finish for additional protection against rust and corrosion
- Suitable for use with 17mm wrenches or sockets

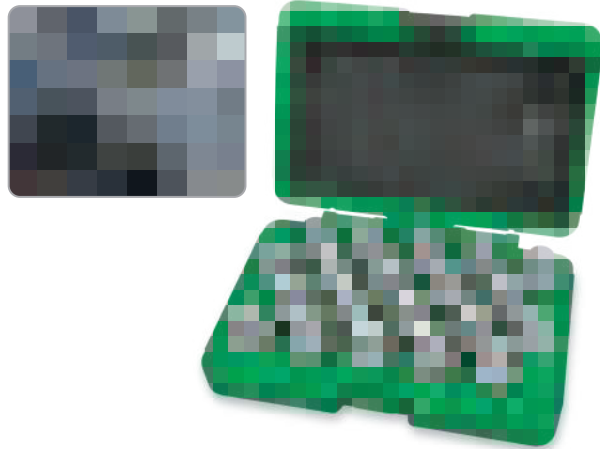

ITEM NO.	CONTENTS	4 (SET)
JGAI2001	20 VW Wheel Lock Nut Key (L=42.5mm) #521, #522, #523, #524, #525, #526, #527, #528, #529, #530, #531, #532, #533, #534, #535, #536, #537, #538, #539, #540	

BLOW CASE: W225 x D163 x H61 (mm)

▶ **5PCS Slide Hammer Gear / Bearing Puller Set**

- Jaws and arms are forged and machined from quality alloy steel, precision heat treated for maximum strength and durability
- 3-jaw pullers evenly apply a pulling force to firmly clamp the internal and external gear or bearing
- Tapered cone adapter (lock nut) securely locks jaws on part to be removed
- Ideal for the extraction of internal and external bearings, seals, press-fitted parts and etc.
- Supplied with a 1.2 kgs slide hammer to facilitate extracting operations



ITEM NO.	CONTENTS	4 (SET)
JGAI0502	1 T-Bar with 1.2kgs Slide Hammer (L=425mm) 1 Internal Gear Puller for Ø 15-30 mm 1 Internal Gear Puller for Ø 30-80 mm 1 External Gear Puller for Ø 15-80 mm 1 Lock Nut	

BLOW CASE: W502 x D230 x H80 (mm)

▶ **23PCS VW Wheel Lock Nut Key Set**

- Quickly and easily removes VW locking wheel nuts without damaging wheels or the nuts
- Applicable for most VW models
- Made of Chrome Molybdenum Alloy Steel
- Chrome plated finish for additional protection against rust and corrosion
- Suitable for use with 17mm wrenches or sockets
- Include 17mm Flank Thin Wall Deep Impact Sockets with 1/2" Sq. Drive

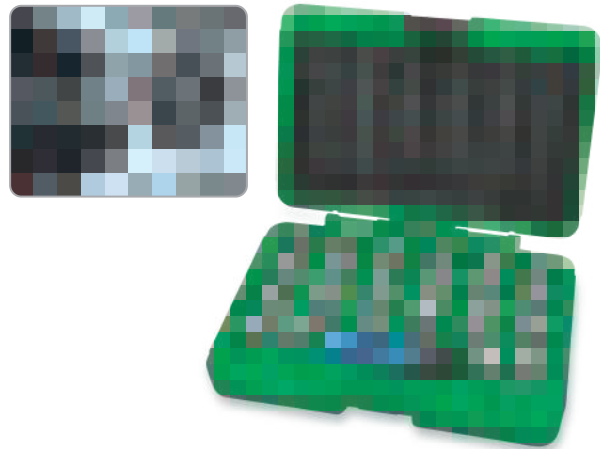

ITEM NO.	CONTENTS	10 (SET)
JGAI2302	12 VW Multi-Ribe Wheel Lock Nut Key (L=30mm) #51/6PT, #52/7PT, #53/8PT, #54/9PT, #55/10PT, #56/11PT, #57/12PT, #58/13PT, #59/14PT, #60/15PT, #61/16PT, #62/17PT 10 VW Spline Points Wheel Lock Nut Key (L=30mm) ABC0/10PT, ABC1/11PT, ABC2/13PT, ABC3/14PT, ABC4/15PT, ABC5/16PT, ABC6/17PT, ABC7/19PT, ABC8/20PT, ABC9/21PT 1 1/2" Dr. 6PT Flank Pro-Series Thin Wall Deep Impact Sockets with Plastic Sleeves (L=86mm) 17mm	

BLOW CASE: W225 x D163 x H61 (mm)

▶ **Valve Stem Seal Pliers**

- Hardened jaws manufactured from Chrome Molybdenum Alloy Steel (CR-MO)
- Serrated tip inside the jaws firmly grips both original equipment and aftermarket valve stem seals
- Small head and extra long neck design allow the tip to reach into confined area of the seal for easy removal
- Ideal for removing valve stem seals in multi-valves engine



ITEM NO.	LENGTH (mm)	12	48
JDAT0109	250 (10")		
JDAT0110	275 (11")		

▶ **Pneumatic Suction Dent Puller**

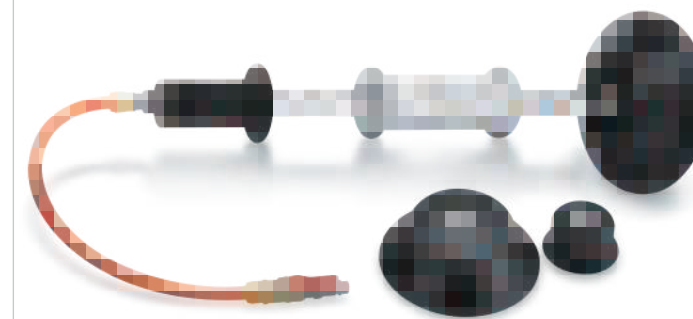

- Large dent puller with pneumatic control to create a strong vacuum to easily pull dents out of panels
- The suction cups hold the panel and the slide hammer pulls out dents without damage to the paint work
- Dent puller suction pads are made of premium soft rubber material
- Supplied with 3 different dimensions of suction pads for various dent size
- Ideal for initial panel reshaping

- Specifications:**
- Air exhaust from the handle
 - Air Inlet: 1/4" PT
 - Working Pressure: 70-170 PSI (5-12 BAR)



ITEM NO.	CONTENTS	4 (SET)
JFJA0615	1 Sliding Hammer Assembly (3 lbs / 1.36 kgs) 1 Suction Pad Ø 150 mm 1 Suction Pad Ø 120 mm 1 Suction Pad Ø 60 mm 1 Air Inlet Hose (L=330mm) 1 Air Inlet Nipple 1/4" PT (Male) European Type (Item No. JFJA0615E) Japanese Type (Item No. JFJA0615J)	

TOPTUL ACCESSORIES



TRUCK KING



TOPTUL SUMMER T-SHIRT
AXG00031002-07 (S-3L)



- Environmentally Friendly ABS Plastic
- Premium Die-Cast Alloy Metal
- Detachable Trailer
- Rolling Wheels
- Openable Rear Door

TOPTUL TOY TRUCK
WITH CONTAINER & ROLLING WHEELS
AXG00034000

- It runs forward depend on inertia. Pull it back and then release, it will run forward
- Material: Die-Cast Alloy Metal & ABS Plastic
- Overall Dimension: 310(L)x50(W)x80(H) mm
- Approx. Weight: 220g